

UMX-TP-TX100R



SAFETY INSTRUCTIONS

Class II apparatus construction.

The equipment should be operated only from the power source indicated on the product.

To disconnect the equipment safely from power, remove the power cord from the rear of the equipment, or from the power source. The MAINS plug is used as the disconnect device, the disconnect device shall remain readily operable.

There are no user-serviceable parts inside of the unit. Removal of the cover will expose dangerous voltages. To avoid personal injury, do not remove the cover. Do not operate the unit without the cover installed.

The apparatus shall not be exposed to dripping or splashing and that no objects filled with liquids, such as vases, shall be placed on the apparatus. No naked flame sources, such as lighted candles, should be placed on the apparatus.

The appliance must be safely connected to multimedia systems. Follow instructions described in this manual.

Ventilation

For the correct ventilation and avoid overheating ensure enough free space around the appliance. Do not cover the appliance, let the ventilation holes free and never block or bypass the ventilators (if any).

WARNING

To prevent injury, the apparatus is recommended to securely attach to the floor/wall or mount in accordance with the installation instructions.

WEEE (Waste Electrical & Electronic Equipment)

Correct Disposal of This Product

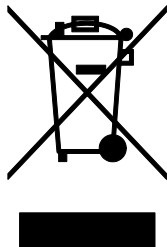

This marking shown on the product or its literature, indicates that it should not be disposed with other household wastes at the end of its working life. To prevent possible harm to the environment or human health from uncontrolled waste disposal, please separate this from other types of wastes and recycle it responsibly to promote the sustainable reuse of material resources.

Household users should contact either the retailer where they purchased this product, or their local government office, for details of where and how they can take this item for environmentally safe recycling.

Business users should contact their supplier and check the terms and conditions of the purchase contract. This product should not be mixed with other commercial wastes for disposal.

Table of contents

| | |
|---|-----------|
| 1. INTRODUCTION..... | 8 |
| 2. GENERAL DESCRIPTION..... | 8 |
| 2.1. BOX CONTENTS..... | 8 |
| 2.2. FEATURES..... | 8 |
| 2.3. TYPICAL APPLICATIONS..... | 10 |
| 2.4. UNDERSTANDING EDID..... | 11 |
| 2.4.1. Basics..... | 11 |
| 2.4.2. Common problems related to EDID..... | 11 |
| 2.5. ADVANCED EDID MANAGEMENT..... | 12 |
| 2.6. HDCP MANAGEMENT..... | 12 |
| 2.6.1. HDCP key caching..... | 12 |
| 2.6.2. Avoiding unnecessary HDCP encryption..... | 12 |
| 2.7. PIXEL ACCURATE RECLOCKING..... | 14 |
| 3. CONTROLS AND CONNECTIONS..... | 15 |
| 3.1. UMX-TP-TX100R FRONT VIEW..... | 15 |
| 3.2. UMX-TP-TX100R REAR VIEW..... | 16 |
| 4. ELECTRICAL CONNECTIONS..... | 17 |
| 4.1. HDMI INPUT..... | 17 |
| 4.2. VGA INPUT..... | 17 |
| 4.3. DIGITAL AUDIO INPUT CONNECTOR..... | 18 |
| 4.4. ANALOG STEREO AUDIO INPUT CONNECTORS..... | 18 |
| 4.5. TWISTED PAIR OUTPUTS..... | 19 |
| 4.6. RS-232 PORT..... | 20 |
| 5. INSTALLATION..... | 21 |
| 5.1. MOUNTING OF UMX-TP-TX100R..... | 21 |
| 5.1.1. Rack shelf..... | 21 |
| 5.1.2. Under desk mounting kit double..... | 21 |
| 5.2. MAXIMUM TWISTED PAIR DISTANCES..... | 21 |
| 5.3. ABOUT SERIAL DEVICES..... | 22 |
| 5.3.1. General information about serial communication..... | 22 |
| 5.3.2. Type of serial cables..... | 22 |
| 5.3.3. Example connection diagrams..... | 22 |
| 5.4. CONNECTING SERIAL DEVICES..... | 23 |
| 5.5. OPERATION MODES..... | 24 |
| 5.5.1. Control mode..... | 24 |
| 5.5.2. Pass-through mode..... | 24 |
| 5.5.3. Changing the working mode..... | 25 |
| 5.5.4. Detailed example:..... | 25 |
| 5.6. POWERING DEVICE..... | 26 |
| 5.6.1. Boot up of HDMI-TP extender units..... | 27 |
| 6. OPERATION OF UMX-TP-TX100R..... | 28 |
| 6.1. FRONT PANEL LEDs..... | 28 |
| 6.2. INPUT SELECTION..... | 29 |
| 6.2.1. VIDEO INPUT selection..... | 29 |
| 6.2.2. AUDIO INPUT selection..... | 29 |
| 6.2.3. AUTOSELECT mode..... | 30 |
| 6.2.4. Audio input in AUTOSELECT mode..... | 31 |
| 6.3. ABOUT EDID MEMORY..... | 32 |
| 6.3.1. EDIDs are referred with Lightware Matrix Controller..... | 32 |
| 6.3.2. EDIDs are referred with rotary switches..... | 33 |
| 6.3.3. The assigning table..... | 33 |
| 6.4. EDID TYPES..... | 34 |
| 6.4.1. Factory preset EDID list..... | 34 |

| | | |
|-----------|---|-----------|
| 6.5. | LEARNING THE EDID | 35 |
| 6.6. | SWITCHING THE EDID | 35 |
| 6.7. | DELETING THE EDID | 36 |
| 6.8. | INVALID EDID ON ANY INPUT | 36 |
| 6.9. | HDCP MANAGEMENT | 36 |
| 6.10. | NO SYNC COLOR | 37 |
| 6.11. | HARDWARE RESET | 37 |
| 6.12. | RELOAD FACTORY DEFAULTS | 37 |
| 7. | SOFTWARE CONTROL – USING THE LIGHTWARE MATRIX CONTROLLER | 38 |
| 7.1. | INSTALLING THE MATRIX CONTROLLER SOFTWARE | 38 |
| 7.2. | ESTABLISHING THE CONNECTION | 39 |
| 7.3. | CONTROL MENU | 41 |
| 7.3.1. | Switch | 41 |
| 7.3.2. | Toggle between the working modes | 41 |
| 7.3.3. | Input parameter settings | 41 |
| 7.3.4. | Output parameter settings | 46 |
| 7.4. | EDID MENU | 46 |
| 7.4.1. | EDID Router operation | 46 |
| 7.4.2. | Advanced EDID Editor | 48 |
| 7.4.3. | Easy EDID Creator | 49 |
| 7.5. | TERMINAL MENU | 49 |
| 7.6. | STATUS MENU | 50 |
| 7.6.1. | Generate report file | 50 |
| 7.6.2. | Browse command file | 51 |
| 7.7. | FIND MENU | 51 |
| 8. | PROGRAMMERS REFERENCE | 52 |
| 8.1. | SERIAL PORT SETTINGS | 52 |
| 8.2. | PROTOCOL DESCRIPTION | 52 |
| 8.3. | STATUS AND IDENTIFICATION COMMANDS | 54 |
| 8.3.1. | View product type | 54 |
| 8.3.2. | View serial number | 54 |
| 8.3.3. | View Firmware version of the CPU | 54 |
| 8.3.4. | View installed controllers' firmware | 54 |
| 8.3.5. | View device's temperature | 54 |
| 8.3.6. | View CPU firmware compile time | 55 |
| 8.3.7. | View installed I/O boards | 55 |
| 8.4. | SYSTEM COMMANDS | 55 |
| 8.4.1. | Query current control protocol | 55 |
| 8.4.2. | Change RS-232 baud rate | 56 |
| 8.4.3. | Query RS-232 baud rate | 56 |
| 8.4.4. | Reload factory defaults | 56 |
| 8.4.5. | Set the RS-232 operation mode | 57 |
| 8.4.6. | Query the RS-232 operation mode | 57 |
| 8.4.7. | Count HDCP keys | 57 |
| 8.4.8. | Clear HDCP key cache | 58 |
| 8.4.9. | Restart matrix router | 58 |
| 8.4.10. | View error list | 58 |
| 8.4.11. | Configure remote alerts | 59 |
| 8.4.12. | Query level of remote alerts | 59 |
| 8.4.13. | Set the priority settings | 59 |
| 8.4.14. | Query the priority settings | 60 |
| 8.5. | EDID ROUTER COMMANDS | 60 |
| 8.5.1. | Save EDID to user memory (Learn EDID) | 60 |
| 8.5.2. | View emulated EDIDs on all inputs | 60 |
| 8.5.3. | Watch EDID validity table | 61 |
| 8.5.4. | View EDID header | 61 |
| 8.5.5. | Download EDID content from the router | 62 |
| 8.5.6. | Upload EDID content to the router | 62 |
| 8.5.7. | Delete EDID from memory | 63 |

| | | |
|------------|--|-----------|
| 8.6. | CONTROL COMMANDS | 63 |
| 8.6.1. | Switch one input to one output | 64 |
| 8.6.2. | View video connection on the output | 64 |
| 8.6.3. | View all connections on the output | 64 |
| 8.6.4. | Rename an input | 65 |
| 8.6.5. | Rename the output | 65 |
| 8.6.6. | Read an input's name | 65 |
| 8.6.7. | Read the output's name | 65 |
| 8.6.8. | Reload default input names | 65 |
| 8.6.9. | Reload default output name | 66 |
| 8.7. | PORT STATUS COMMANDS | 66 |
| 8.7.1. | Input port status | 66 |
| 8.7.2. | Output port status | 66 |
| 8.7.3. | All port status | 66 |
| 8.8. | INPUT PROPERTIES | 67 |
| 8.8.1. | Set input port properties | 67 |
| 8.8.2. | Query input port properties | 69 |
| 8.8.3. | Set analog timing properties | 70 |
| 8.8.4. | Query analog timing properties | 70 |
| 8.8.5. | Reset analog timing properties | 70 |
| 8.8.6. | Set analog color properties | 71 |
| 8.8.7. | Save analog color properties | 71 |
| 8.8.8. | Query analog color properties | 72 |
| 8.8.9. | Reset analog color properties | 72 |
| 8.8.10. | Set analog input audio parameters | 72 |
| 8.8.11. | Query analog input audio properties | 73 |
| 8.8.12. | Set the color of no sync picture | 73 |
| 8.8.13. | Query the color of no sync picture | 73 |
| 8.8.14. | Query timings of the incoming signal | 74 |
| 8.8.15. | Save preset | 74 |
| 8.8.16. | Delete preset | 74 |
| 8.8.17. | Delete all presets | 75 |
| 8.8.18. | Clone preset | 75 |
| 8.8.19. | List presets | 75 |
| 8.8.20. | Delete preset from all input ports | 76 |
| 8.9. | OUTPUT PROPERTIES | 76 |
| 8.9.1. | Set output video properties | 76 |
| 8.9.2. | Query output video properties | 78 |
| 8.10. | ERROR RESPONSES | 78 |
| 9. | COMMANDS – QUICK SUMMARY | 79 |
| 10. | FIRMWARE UPGRADE | 82 |
| 10.1. | SHORT INSTRUCTIONS | 82 |
| 10.2. | DETAILED INSTRUCTIONS | 82 |
| 10.2.1. | Installing and launching the Bootloader software | 82 |
| 10.2.2. | Tips for the upgrade process | 84 |
| 10.2.3. | Firmware upgrade | 84 |
| 10.3. | FORCED FIRMWARE UPGRADE | 87 |
| 11. | TROUBLESHOOTING | 88 |
| 12. | SPECIFICATIONS | 89 |
| 13. | MECHANICAL DRAWINGS | 93 |
| 14. | VERSION APPLICABILITY | 94 |
| 15. | WARRANTY | 94 |
| 16. | DOCUMENT REVISION HISTORY | 94 |

1. Introduction

Dear Customer,

Thank you for choosing Lightware UMX-TP-TX100R monitor extender.

Lightware's UMX-TP-TX100R is an all-round, universal video and audio transmitter for ever-changing environments such as small board rooms and classrooms. The extender was designed to handle digital and analog video and audio signals e.g. VGA, YPbPr, DVI and HDMI 1.3 with analog stereo, 5.1 S/PDIF and even 7.1 HDMI embedded audio.

2. General description

2.1. Box contents

- UMX-TP-TX100R unit
- Quick Start Guide
- User's manual (this document)
- +12V DC wall plug adaptor

2.2. Features

- **Advanced EDID Management** – The user can emulate any EDID at the extender's inputs independently, read out and store the attached monitor's EDID in the internal memory locations, upload and download EDID files using Matrix Control Software.
- **2.25 Gb/s channel transmission** – Extend any VGA or HDMI signal between 25 and 225 MHz pixel clock frequency conforming to DVI 1.0 and HDMI1.3 standards.
- **Supports all HDTV resolutions** – 720p, 1080i, 1080p 2K etc. HDTV signals up to 225 MHz pixel clock frequency are passed through regardless of the resolution.
- **Control by front and rear panel buttons** – Video and audio source select and EDID address selection with two decimal rotary switches and LEARN EDID button are available for Advanced EDID Management and control the device.
- **RS-232 control** – Simple ASCII based RS-232 protocol is used for switching, status request, etc.
- **Bi-directional RS-232 pass-through** – AV systems can contain serial port controllers and controlled devices. Serial port pass-through supports any unit that works with standard RS-232.
- **Cross compatibility with any Lightware Twisted Pair device** – All devices in the product series are cross compatible thanks to Lightware's attentive design. The transmitter can be paired with any receiver without restriction. With Lightware's hybrid modular matrix concept, it is even possible to connect the extender box directly to the matrix router using an MX-HDMI-TP-IB or MX-DVI-TP-IB+ input boards.
- **Universal power adaptor** – UMX-TP-TX100R transmitter is equipped with a universal +12V DC power adaptor, which accepts AC voltages from 100 to 240 Volts with 50 or 60 Hz line frequency.
- **Locking DC connector** – Special plug of wall adaptor ensures safe power supply. This type of connector prevents unwanted extractions.

- **HDCP compliant** – UMX-TP-TX100R complies with HDCP standard. Lightware is a legal HDCP adopter. Both HDCP encrypted and non-HDCP components can be installed in the same system. The included advanced HDCP management eliminates the need for re-authentication upon switching.
- **30 meter input cable compensation** – Using 22AWG high quality DVI or HDMI cable, the digital inputs are automatically compensated for up to 30 meter cable length at 24bpp, which extends installation possibilities even at the highest HDTV or computer resolutions.
- **Pixel Accurate Reclocking** – (removes jitter caused by long cables) The output has a clean, jitter free signal, eliminating signal instability and distortion caused by long cables or connector reflections.
- **Frame detector and signal analysis** – Using the Lightware Matrix Controller software the exact video and audio signal format can be determined such as timing, frequencies, scan mode, HDCP encryption, color range, color space and audio sample rate.
- **Deep Color support and conversion** – It is possible to transmit the highest quality 36-bit video streams for perfect color reproduction.
- **DVI/HDMI conversion** – The router is able to convert from HDMI to DVI signals so that you can watch HDMI videos on your computer display without audio.
- **Zero frame delay – Even on Analog Inputs** - Lightware's UMX-TP-TX100R add no frame noticeable delay to the switched signal. There is no frame or line period delays to the signals when passing a Lightware device.
- **Separate Audio and Video switching** – Video and audio signals are separated and can be switched independently. Even if the HDMI stream contains embedded audio.
- **Analog Audio and Video A/D conversion** – UMX-TP-TX100R converts uncompressed analog audio and video signal to digital and places it to the output.
- **Rack mounting options** – Several mounting methods ensure universal usage. Units can be placed into standard racks or under flat surfaces.
- **Input (video & audio) status LEDs** – Front panel LEDs give feedback about state of the unit and the video and audio signals.
- **Accepts analog and digital audio signals** - Accepts analog stereo; 5.1 S/PDIF and even 7.1 HDMI embedded audio signals. Analog signals are converted to digital formats and digital or digitized analog audio can be embedded in the video stream.
- **Autoswitch function for video and audio inputs** – Autoselect mode with or without priority can toggles between inputs. It helps the handling of the transmitter and installation of new devices.

2.3. Typical applications

Some typical connection variations with the signal extender are shown on Figure 2-1 and Figure 2-2.

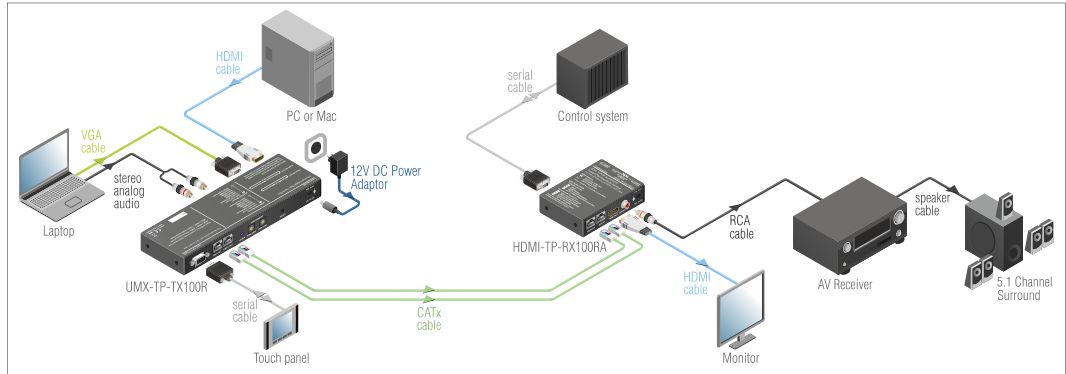

Figure 2-1. Typical stand-alone application for UMX-TP-TX100R

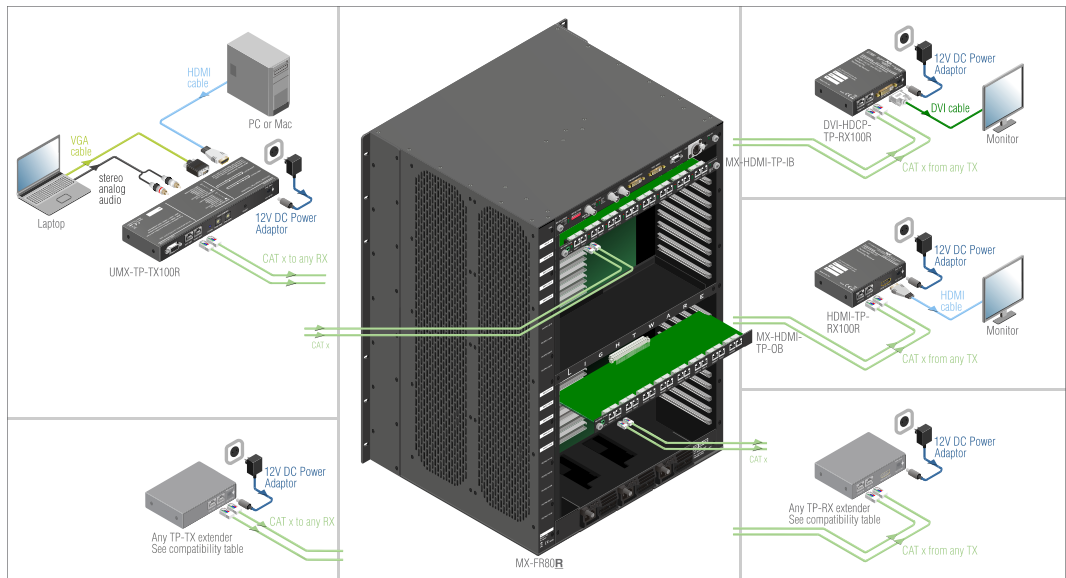

Figure 2-2. Integrated system application for UMX-TP-TX100R

Info: For the compatible Lightware products please see the compatibility table at www.lightware.com.

Application examples

- Small classrooms
- Conference rooms, collaborative telepresence
- Control room
- Home cinema

2.4. Understanding EDID

2.4.1. Basics

EDID stands for Extended Display Identification Data. Simply put, EDID is the passport of display devices (monitors, TV sets, projectors). It contains information about the display's capabilities, such as supported resolutions, refresh rates (these are called Detailed Timings), the type and manufacturer of the display device, etc.

After connecting a DVI source to a DVI display, the source reads out the EDID to determine the resolution and refresh rate of the image to be transmitted.

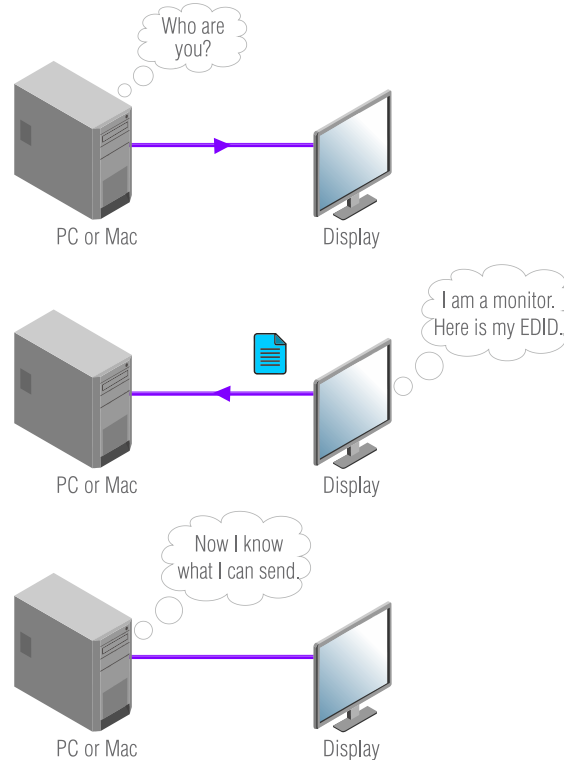

Figure 2-3. EDID communication

Most DVI computer displays have 128-byte long EDID structure. However, Digital Televisions and HDMI capable displays may have another 128 bytes, which is called E-EDID and defined by CEA (Consumer Electronics Association). This extension contains information about additional Detailed Timings, audio capabilities, speaker allocation and HDMI capabilities. It is important to know, that all HDMI capable devices must have CEA extension, but not all devices are HDMI capable which have the extension.

2.4.2. Common problems related to EDID

Problem: „I have changed to a different EDID on an input port of the matrix to have a different resolution but nothing happens.”

Solution: Some graphics cards and video sources read out the EDID only after power-up and later they don't sense that EDID has been changed. You need to restart your source to make it read out the EDID again.

Problem: „I have a UMX-TP-TX100R and I'm using a Lightware factory preset EDID. I would like to be able to choose from different resolutions, but my source allows only one resolution.”

Solution: Most Lightware factory preset EDIDs allow only one resolution, forcing the sources to output only that particular signal. You need to select a Universal EDID. It supports all common VESA resolutions. Additionally it also features audio support.

2.5. Advanced EDID Management

Each DVI sink (e.g. monitors, projectors, plasma displays, and switcher inputs) must support the EDID data structure. Source BIOS and operating systems are likely to query the sink using DDC2B protocol to determine what pixel formats and interface are supported. HDMI standard makes use of EDID data structure for the identification of the monitor type and capabilities. Most DVI sources (graphic cards, set top boxes, etc.) will output DVI signal after accepting the connected sink's EDID information. In case of EDID readout failure or missing EDID the source will not output DVI video signal. UMX-TP-TX100R provides Lightware's Advanced EDID Management function that helps system integration. The built in EDID Router stores and emulates 18 EDID data plus all monitor's EDID that are connected to the output connectors. There are 10 factory preset and 8 user programmable EDIDs. The router stores the EDID of all attached monitors or projectors for the output in a non-volatile memory. This way the EDID from a monitor is available when the monitor is unplugged, or switched off.

Any EDID can be emulated on any input. An emulated EDID can be copied from the EDID router's memory (static EDID emulation), or from the last attached monitors memory (dynamic EDID emulation). For example, the router can be set up to emulate a device, which is connected to the output. In this case the EDID automatically changes, if the monitor is replaced with another display device (as long as it has a valid EDID).

EDID is independently programmable for all inputs without affecting each other. All inputs have their own EDID circuit. EDID Router can be controlled via serial port.

Info: The user is not required to disconnect the HDMI cable to change an EDID as opposed to other manufacturer's products. EDID can be changed even if a source is connected to the input and it is powered ON.

Info: When EDID has been changed, the unit toggles the HOTPLUG signal for 2 seconds. Some sources do not observe this signal, so in this case the change is not recognized by the source. In such cases the source device must be restarted or powered OFF and ON again.

2.6. HDCP management

Lightware Visual Engineering is a legal HDCP adopter, and has developed several functions that helps to solve HDCP related problems.

2.6.1. HDPC key caching

Lightware introduced the HDCP key caching technique in early 2009 that validates all the display keys in an AV system during system boot up and keeps them constantly available for sources. This method eliminates the HDCP handshake at every switch and keeps all sources sending uninterrupted signals.

Without this function the sources should re-authenticate HDCP after each crosspoint switch which makes the displays to drop the signal and go black for 5-8 seconds. The HDCP key caching technique avoids this and allows instantaneous switching between two encrypted signals.

2.6.2. Avoiding unnecessary HDCP encryption

Many video sources send HDCP protected signal if they detect that the sink is HDCP capable – even if the content is not copyrighted. This can cause trouble if a HDCP capable device (e.g. repeater or matrix router) is connected between the source and the display. In this case the content can't be viewed on non-HDCP capable displays and interfaces like event controllers.

Rental and staging technicians often complain about Apple laptops, who always send HDCP encrypted signals if the receiver device (display, matrix router, etc.) reports HDCP compliancy. However HDCP encryption is not required all the time (e.g. computer desktop image) MacBook and MacBookPro still do that.

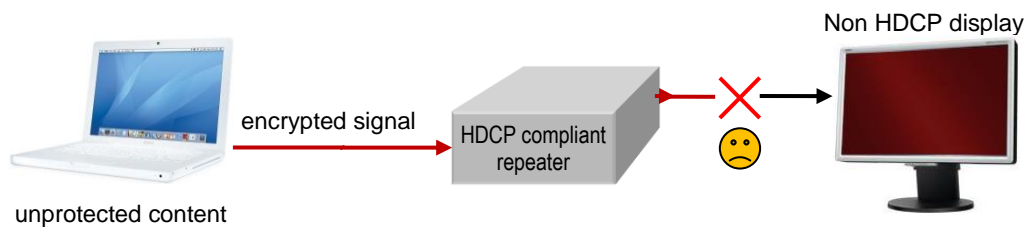

To avoid unnecessary HDCP encryption, Lightware introduced the HDCP enabling/disabling function: the HDCP capability can be disabled on each input port separately. If HDCP is disabled on an input port, the connected source will detect that the sink is not HDCP capable, and turn off authentication. The source will not be able to communicate with any of the devices (displays, repeaters, etc.) that are connected to the routers output, therefore it could not see if they are HDCP capable or not.

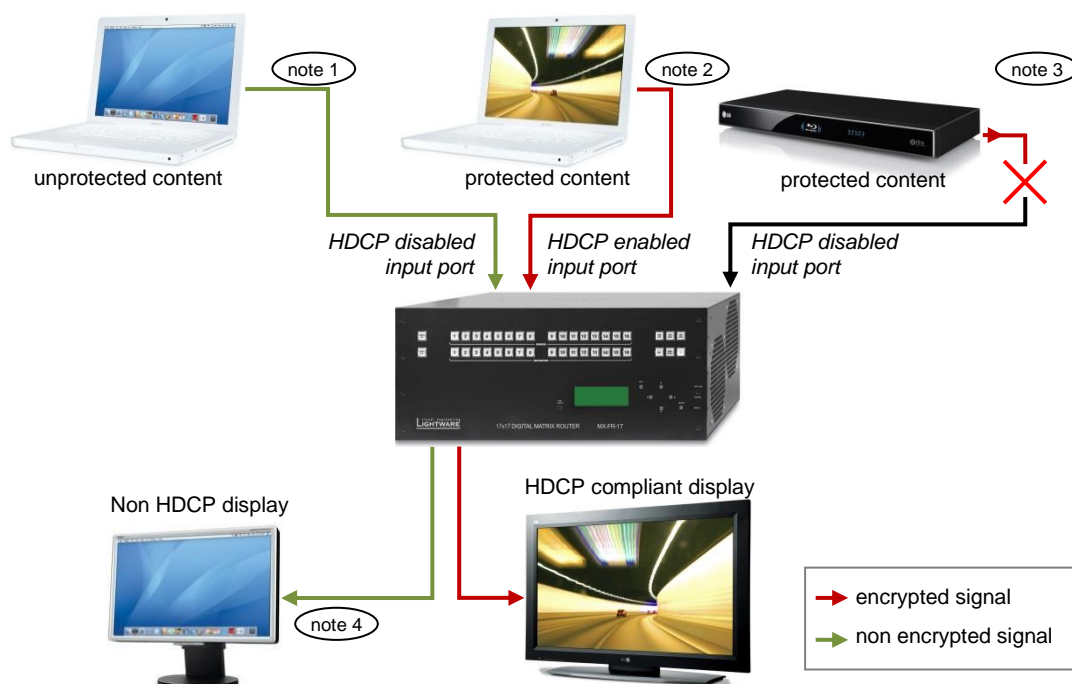

- Note 1: *If a source detects that the input port is HDCP disabled, it will send only unprotected content.*
- Note 2: *If a source detects that the input port is HDCP enabled, it could send protected or unprotected contents as well.*
- Note 3: *HDCP protected content will not be sent to any input port with disabled HDCP setting.*
- Note 4: *HDCP protected content will never be sent to a non HDCP compliant display.*

Please note that if HDCP capability is disabled on an input port, the connected source cannot send protected content to any display. If HDCP function is enabled on an input port and the source sends encrypted signal, the non-HDCP compliant devices cannot display the video. This new feature does not remove the encryption of an encrypted signal, and does not void HDCP standard at all.

2.7. Pixel Accurate Reclocking

Signal reclocking is an essential important procedure in digital signal transmission. After passing the reclocking circuit, the signal becomes stable and jitter-free, and can be transmitted over more equipment like processors, or event controllers. Without reclocking, sparkles, noise and jaggies can be seen on the image.

Lightware's sophisticated Pixel Accurate Reclocking technology fixes more problems than general TMDS reclocking. It removes not only intra-pair skew but inter-pair skew as well.

The Pixel Accurate Reclocking circuit eliminates the following errors:

Intra-pair skew: skew between the + and - wires within a differential wire pair (e.g. Data2- and Data2+). It's caused by different wire lengths or slightly different wire construction (impedance mismatch) in HDMI cable. It results in jitter.

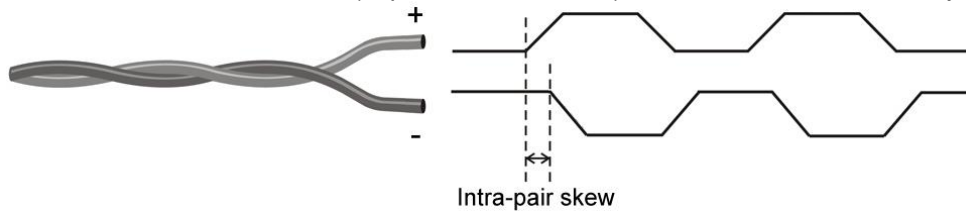

Inter-pair skew: skew between two differential wire pairs in a cable. It's caused by different wire pair lengths or different number of twists in the HDMI cable. Too much inter-pair skew results in color shift in the picture or sync loss.

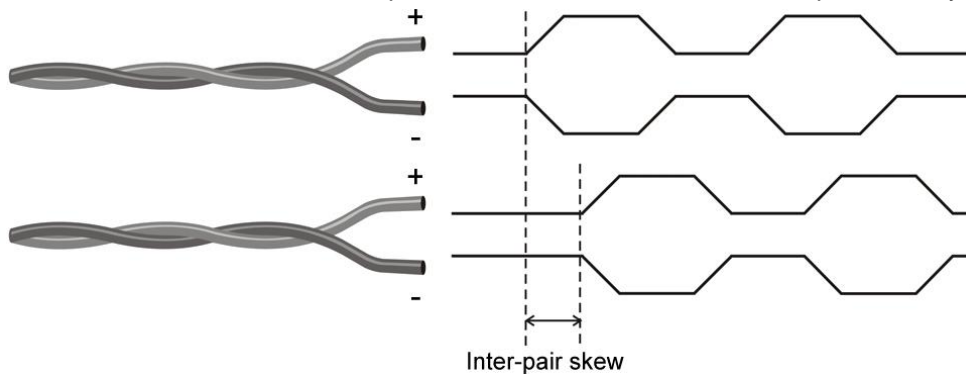

Jitter: signal instability in the time domain. The time difference between two signal transitions should be a fix value, but noise and other effects cause variations.

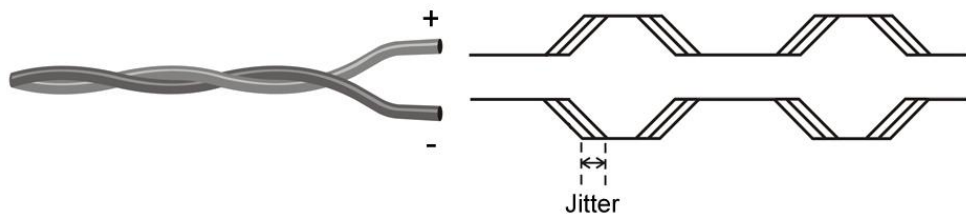

Noise: electromagnetic interference between other electronic devices such as mobile phones, motors, etc. and the HDMI cable are coupled onto the signal. Too much noise results in increased jitter.

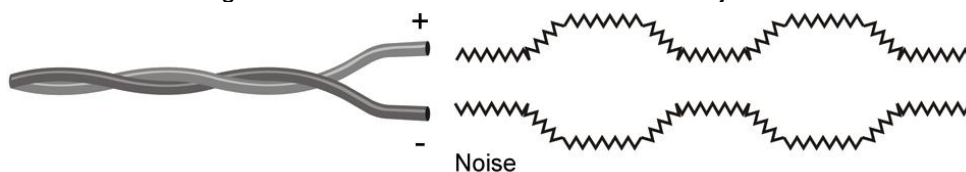

The Pixel Accurate Reclocking circuit completely regenerates the original video signal and outputs a strong, high-quality digital signal that conforms to the HDMI specification.

3. Controls and connections

3.1. UMX-TP-TX100R front view



Figure 3-1. UMX-TP-TX100R front view

- | | |
|------------------------------------|---|
| <p>1 HDMI input</p> | <p>Connect one HDMI cable between the HDMI source and the transmitter unit. For more information see chapter 4.1 on page 17.</p> |
| <p>2 VGA input</p> | <p>Connect one VGA cable between the analog video source and the transmitter unit. For more information see chapter 4.2 on page 17.</p> |
| <p>3 S/PDIF input</p> | <p>RCA jack connector with S/PDIF digital audio signal. For more information see chapter 4.3 on page 18.</p> |
| <p>4 Analog audio input</p> | <p>Double RCA jack connector for analog stereo audio input signal with right and left channel. For more information see section 4.4 on page 18.</p> |
| <p>5 Status LEDs</p> | <p>The LEDs give feedback about state of the unit and the video and audio signals. For more information about names and meanings of the Status LEDs see chapter 6.1 on page 28.</p> |
| <p>6 VIDEO select</p> | <p>Switching between video inputs (HDMI / VGA / Autoselect) is available with the VIDEO select button. For more information see section 6.2.1 on page 29.</p> |
| <p>7 AUDIO select</p> | <p>Switching between audio inputs (HDMI / ANALOG / S/PDIF) is available with the AUDIO select button. For more information see section 6.2.2 on page 29.</p> |

3.2. UMX-TP-TX100R rear view

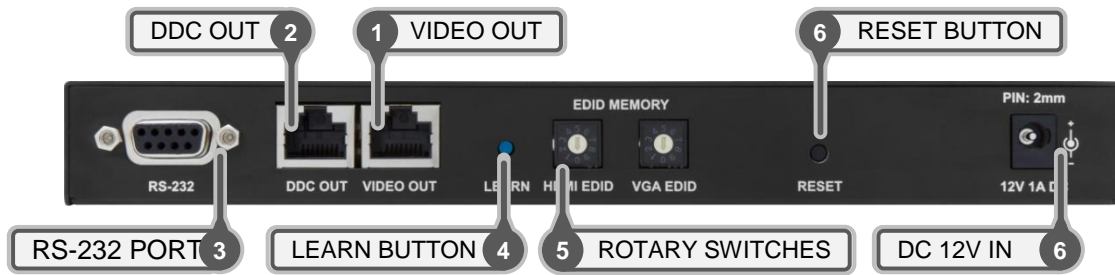

Figure 3-2. UMX-TP-TX100R rear view

- 1 VIDEO OUT**

Connect a Twisted Pair cable (CAT7 recommended) between the VIDEO OUT of the transmitter unit and the VIDEO IN of the receiver unit. (e.g. HDMI-TP-RX100RA or a Lightware Hybrid Matrix equipped with twisted pair input cards). For more information see chapter [4.5](#) on page [19](#).
- 2 DDC OUT**

Connect a Twisted Pair cable (CAT7 recommended) between DDC OUT of the transmitter unit and the DDC IN of the receiver unit (e.g. HDMI-TP-RX100RA or a Lightware Hybrid Matrix equipped with twisted pair input cards). For more information see chapter [4.5](#) on page [19](#).
- 3 RS-232 port**

9-pole D-sub female connector for standard RS-232 port. Connect a serial cable between the transmitter unit and the serial device. RS-232 pass-through, Advanced EDID management and firmware upgrades are available via the RS-232 interface. For more information see chapters [4.6](#) and [5.3](#) - [5.5.4](#) on pages [20](#) and [22](#) - [25](#).
- 4 LEARN button**

Stores the EDID of the display device attached to receiver device's video output in the selected memory address between #6...#9. To learn the EDID, select an appropriate address with the rotary switches and press and hold the Learn button for two seconds. For more information see chapter [6.5](#) on page [35](#).
- 5 Rotary switches**

The rotary switch selects one of 9 addresses on both input port. EDID memories #1 .. #5 contain factory presets and #6 .. #9 are user programmable. Address #0 enable dynamic EDID emulation which copies EDID from receiver device's video output. For more information see chapter [6.6](#) on page [35](#). Use a flat head screwdriver that fits into the actuator. Avoid the use of keys, coins, knives and other sharp objects because they might cause permanent damage to the rotary switches.
- 6 Reset button**

Hardware reset button. It resets the whole device, however saved settings and EDIDs will be preserved.
- 7 DC 12V in**

Connect the output of the supplied +12V DC power adaptor. **CAUTION! Warranty void if damage occurs due to use of a different power source.**

Info: The UMX-TP-TX100R does not have networking capabilities. Do not connect the RJ45 output(s) of the UMX-TP-TX100R to a Local Area Network device or a PC. Doing so may damage the unit!

4. Electrical connections

4.1. HDMI Input

UMX-TP-TX100R provides standard 19 pole HDMI connector for inputs. Always use high quality HDMI cable for connecting sources and displays.

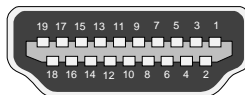

HDMI Type A receptacle

| Pin | Signal | Pin | Signal |
|-----|-------------------|-----|------------------------|
| 1 | TMDS Data2+ | 11 | TMDS Clock Shield |
| 2 | TMDS Data2 Shield | 12 | TMDS Clock- |
| 3 | TMDS Data2- | 13 | CEC |
| 4 | TMDS Data1+ | 14 | Reserved |
| 5 | TMDS Data1 Shield | 15 | SCL |
| 6 | TMDS Data1- | 16 | SDA |
| 7 | TMDS Data0+ | 17 | DDC/CEC/HEC Ground |
| 8 | TMDS Data0 Shield | 18 | +5 V Power (max 50 mA) |
| 9 | TMDS Data0- | 19 | Hot Plug Detect |
| 10 | TMDS Clock+ | | |

Table 4-1. HDMI connector pin assignments

4.2. VGA Input

UMX-TP-TX100R provides standard 15 pole D-SUB female connector for VGA inputs. Always use high quality VGA cable for connecting sources and displays.

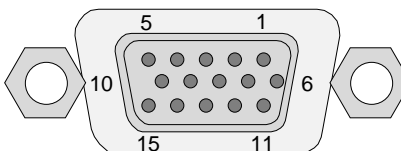

Figure 4-1. D-SUB 15 pole female connector (DE15F)

| Pin nr. | Name | Description |
|---------|-------|--|
| 1 | RED | Red Video (75 ohm, 0.7 V p-p) |
| 2 | GREEN | Green Video (75 ohm, 0.7 V p-p) |
| 3 | BLUE | Blue Video (75 ohm, 0.7 V p-p) |
| 4 | ID2 | Monitor ID Bit (Not used, internally connected to Pin 5) |
| 5 | GND | Ground |
| 6 | RGND | Red Ground (Internally connected to Pin 5) |
| 7 | GGND | Green Ground (Internally connected to Pin 5) |
| 8 | BGND | Blue Ground (Internally connected to Pin 5) |
| 9 | KEY | Optional +5V output from graphics card |
| 10 | SGND | Sync Ground (Internally connected to Pin 5) |
| 11 | ID0 | Monitor ID Bit 0 (Not used, internally connected to Pin 5) |
| 12 | SDA | I ² C bidirectional data line |
| 13 | HSYNC | Horizontal Sync |
| 14 | VSYNC | Vertical Sync which works also as data clock |
| 15 | SCL | I ² C data clock in DDC2 |

Table 4-2. D-sub connector pin assignment for standard VGA

4.3. Digital audio input connector

UMX-TP-TX100R has standard RCA receptacles for digital coaxial audio input.

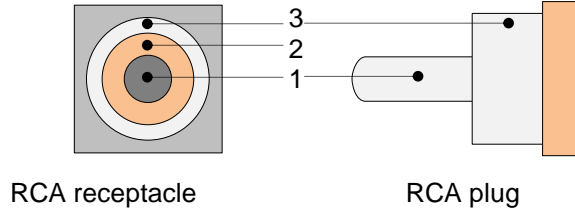

| Nr. | Name |
|-----|------------------------|
| 1 | S/PDIF input or output |
| 2 | Plastic insulator |
| 3 | GND |

Table 4-3. RCA connector pin assignments for digital audio

Info: Plugs and sockets on consumer equipment are conventionally color-coded by CEA/CEDIA-863-B (ANSI) to aid correct connections. According to the standard Lightware uses orange colored RCA connectors for S/PDIF signals.

4.4. Analog stereo audio input connectors

UMX-TP-TX100R has standard RCA receptacle for analog stereo audio input. Input works with standard line-in voltage levels.

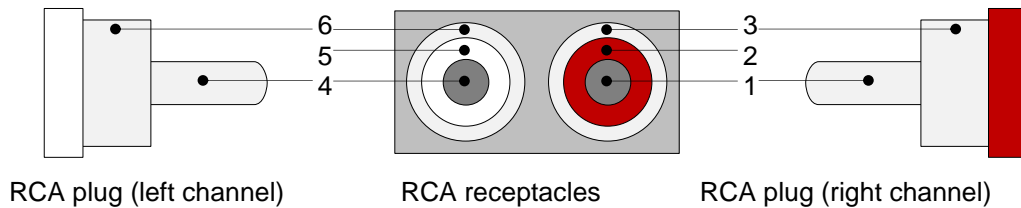

| Nr. | Name |
|-----|-------------------------------|
| 1 | Right channel input or output |
| 2 | Plastic insulator |
| 3 | GND |
| 4 | Left channel input or output |
| 5 | Plastic insulator |
| 6 | GND |

Table 4-4. RCA connector pin assignments for analog audio

Info: Plugs and sockets on consumer equipment are conventionally color-coded by CEA/CEDIA-863-B (ANSI) to aid correct connections. According to the standard Lightware uses red colored RCA connectors for right channel of analog stereo audio signals and white colored RCA connectors for left channel of analog stereo audio signals.

4.5. Twisted Pair outputs

UMX-TP-TX100R provides standard RJ-45 connectors for VIDEO OUT and DDC OUT.



| Pin | VIDEO OUT | DDC OUT |
|-----|-------------|-----------------------|
| 1 | TMDS Data0+ | CEC (out) |
| 2 | TMDS Data0- | Hot Plug Detect (out) |
| 3 | TMDS Clock+ | RS-232 RX |
| 4 | TMDS Data1+ | DDC CLK |
| 5 | TMDS Data1- | +12V (out) |
| 6 | TMDS Clock- | RS-232 TX |
| 7 | TMDS Data2+ | DDC SDA |
| 8 | TMDS Data2- | GND |

Table 4-5. RJ45 input and output connector pin assignment

Warning: Avoid interchanging the connection to the VIDEO and DDC lines!

Wiring of RJ45 plugs

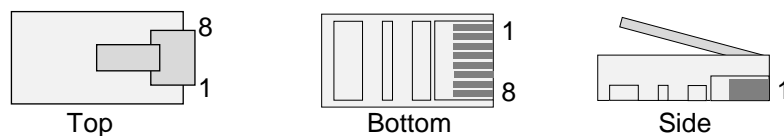

Lightware recommends the termination of TP cables on the basis of TIA/EIA T 568 A or TIA/EIA T 568 B standards.

| Pin | Name | TIA/EIA T568 A | color and name | TIA/EIA T568 B | color and name |
|-----|----------|----------------|---------------------|----------------|---------------------|
| 1 | TX + | | white/green stripe | | white/orange stripe |
| 2 | TX - | | green solid | | orange solid |
| 3 | RX + | | white/orange stripe | | white/green stripe |
| 4 | Not used | | blue solid | | blue solid |
| 5 | Not used | | white/blue stripe | | white/blue stripe |
| 6 | RX - | | orange solid | | green solid |
| 7 | Not used | | white/brown stripe | | white/brown stripe |
| 8 | Not used | | brown solid | | brown solid |

Table 4-6. Recommended termination of TP cables

4.6. RS-232 port

UMX-TP-TX100R has RS-232 pass-through function or can be remote controlled through industry standard 9 pole D-SUB female connector. The extender uses RS-232 port.

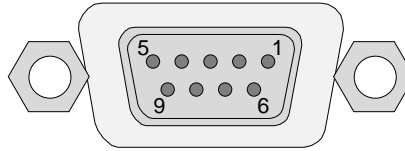

Figure 4-2. D-SUB 9 pole female connector (DE9F)

| Pin nr. | RS-232 |
|---------|-------------------------------------|
| 1 | NC - non connected |
| 2 | TX data transmit (output) |
| 3 | RX data receive (input) |
| 4 | DTR (Internally connected to Pin 6) |
| 5 | GND signal ground (shield) |
| 6 | DSR (Internally connected to Pin 4) |
| 7 | RTS (Internally connected to Pin 8) |
| 8 | CTS (Internally connected to Pin 7) |
| 9 | NC - non connected |

Table 4-7. D-sub connector pin assignment for standard RS-232

5. Installation

5.1. Mounting of UMX-TP-TX100R

To mount extender unit Lightware supplies optional accessories for different usage. All kind of mounting kits have a similar fixing method. UMX-TX-TX100R extender unit has two mounting holes with inner thread on the bottom side. Fasten the device by screwing the enclosed M3x6 mm cross recessed, countersunk head screws (DIN 965A) through two holes of the shelf into the TP's mounting hole.

To order mounting accessories please contact sales@lightware.com.

5.1.1. Rack shelf

Allows rack mounting for half-rack, quarter-rack and pocket sized units.

1U high rack shelf provides mounting holes for fastening two half-rack or four quarter-rack sized units. Pocket sized devices can also be fastened on the self.

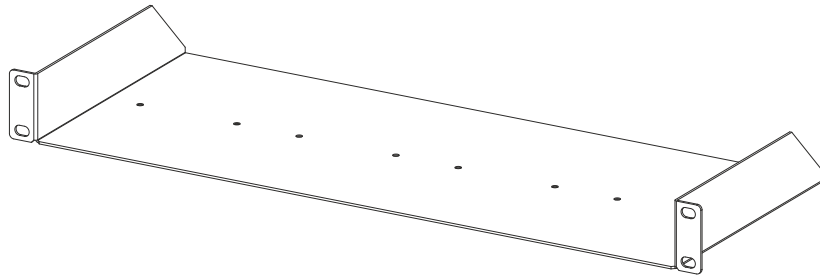

5.1.2. Under desk mounting kit double

The UD-kit double makes it easy to mount a single device on any flat surface (e.g. furniture).

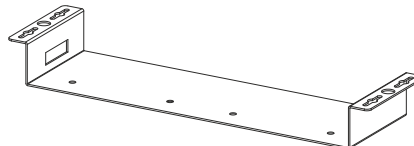

5.2. Maximum twisted pair distances

The following table shows the maximum twisted pair distances. The actual achievable distances may differ, depending on the topology of the whole system. Unshielded Twisted Pair (UTP) cables are susceptible to EMI coming from surrounding devices (cables, mobile phones, motors, etc.). Noisy environments substantially decrease the usable length of unshielded cables. Hence the use of shielded Category 6 cables or Category 7 cables is always recommended. Category 7 cables are screened and foiled by standard.

| Resolution | Vfreq (Hz) | Pixel clk freq. (MHz) | Cat5e UTP | Cat5e FTP | Cat6 UTP | Cat6 FTP | Cat6 S/FTP | Cat7 S/FTP |
|--------------|------------|-----------------------|-----------|-----------|----------|----------|------------|------------|
| 640 x 480 | 60 | 25,2 | 60 m | 60 m | 65 m | 70 m | 70 m | 80 m |
| 800 x 600 | 60 | 40,0 | 60 m | 60 m | 65 m | 65 m | 65 m | 75 m |
| 1024 x 768 | 60 | 65,0 | 55 m | 55 m | 60 m | 60 m | 60 m | 75 m |
| 1280 x 720p | 60 | 74,2 | 55 m | 55 m | 60 m | 60 m | 60 m | 70 m |
| 1280 x 1024 | 60 | 108,0 | 50 m | 50 m | 55 m | 60 m | 60 m | 65 m |
| 1400 x 1050 | 60 | 121,8 | 45 m | 45 m | 45 m | 55 m | 55 m | 60 m |
| 1600 x 1200 | 60 | 162,0 | 30 m | 35 m | 35 m | 45 m | 45 m | 50 m |
| 1920 x 1080p | 60 | 148,5 | 30 m | 35 m | 35 m | 45 m | 45 m | 50 m |
| 1920 x 1200p | 60 | 153,0 | 30 m | 35 m | 35 m | 45 m | 45 m | 50 m |

Table 5-1. Maximum twisted pair distances

5.3. About serial devices

5.3.1. General information about serial communication

In our aspect there are two type of devices in general serial communication:

- **Data Terminal Equipment** – Data Terminal Equipment (DTE) is an end instrument that converts user information into signals or reconverts received signals. Typical DTE devices: computers, LCD touch panels and control systems.
- **Data Circuit-terminating Equipment** – Data Circuit-terminating Equipment (DCE) is a device that sits between the DTE and a data transmission circuit. It also called data communication equipment and data carrier equipment. Typical DCE devices: projectors, industrial monitors and amplifiers.

Among others the pin assignment is different between DTE and DCE.

| | DTE | DCE |
|---------------|-----|-----|
| Pin 2: | RD | TD |
| Pin 3: | TD | RD |

RD: Received Data (digital input)

TD: Transmitted Data (digital output)

Info:

UMX-TP-TX100R is DCE units according to their pin-out.

Different type of serial cables must be used between different serial devices.

| | DTE | DCE |
|------------|------------|-------------|
| DTE | Null-modem | Straight |
| DCE | Straight | Null-modem* |

* in general contact DCE with DCE by tail-circuit serial cable. To connect UMX-TP-TX100R and a DCE unit use male-male null-modem cable.

5.3.2. Type of serial cables

- **Straight serial cable** – straight pin-outs both ends

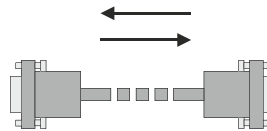

- **Null-modem serial cable** – straight pin-out at the one end and cross pin-out at the other end. (Interchange lines of TX and RX).

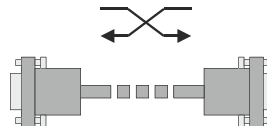

5.3.3. Example connection diagrams

The following cases are examples. Devices may have different receptacles and pin-outs.

- **To extend RS-232 between controller system (DTE) and projector (DCE).**

Connect straight serial cable between controller system (DTE) and the UMX-TP-TX100R transmitter (DCE) and null-modem serial cable between HDMI-TP-TX100RA receiver (DCE) and projector (DCE).

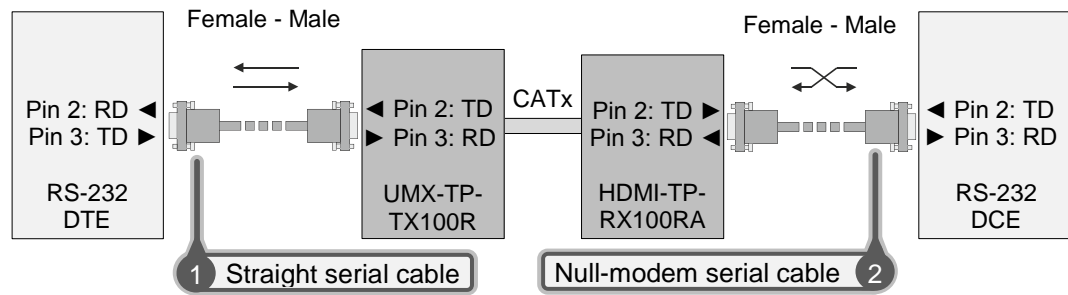

- **To extend RS-232 between computer (DTE) and computer (DTE).**

Connect straight serial cable between controller system (DTE) and the UMX-TP-TX100R transmitter (DCE) and straight serial cable between HDMI-TP-TX100RA receiver (DCE) and computer (DTE).

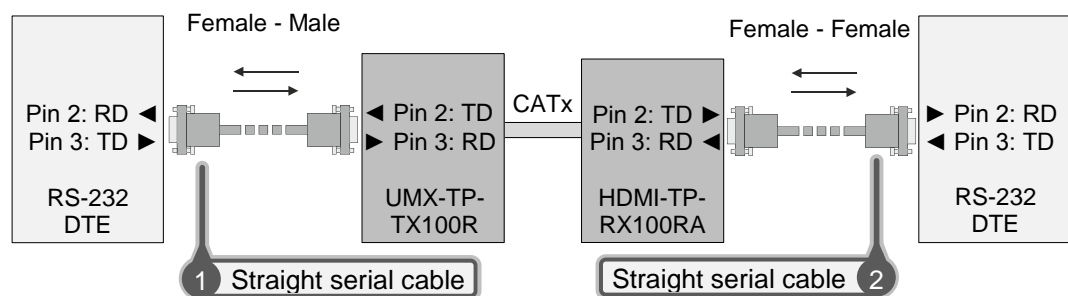

5.4. Connecting serial devices

Serial cables between devices may have male or female plugs and their type may be straight or null-modem.

Info

The cable type does not depend on the plug type.

Use of the RS-232 pass-through or the control mode places extender units* between serial devices in the topology. TP extension functions as an extra-long straight serial cable. So out of the Serial cables #2a and #2b, one must be the same type (e.g. straight or null-modem) as Serial cable #1 and the other one must be a straight serial cable. If cable's plug and device's receptacle do not match get a suitable cable or use a gender changer.

* Extender units can be UMX-TP-TX100R and any Lightware TP receiver or Lightware Hybrid Matrix equipped with double slot twisted pair input cards, etc. For the compatible Lightware products please see the compatibility table at www.lightware.com.

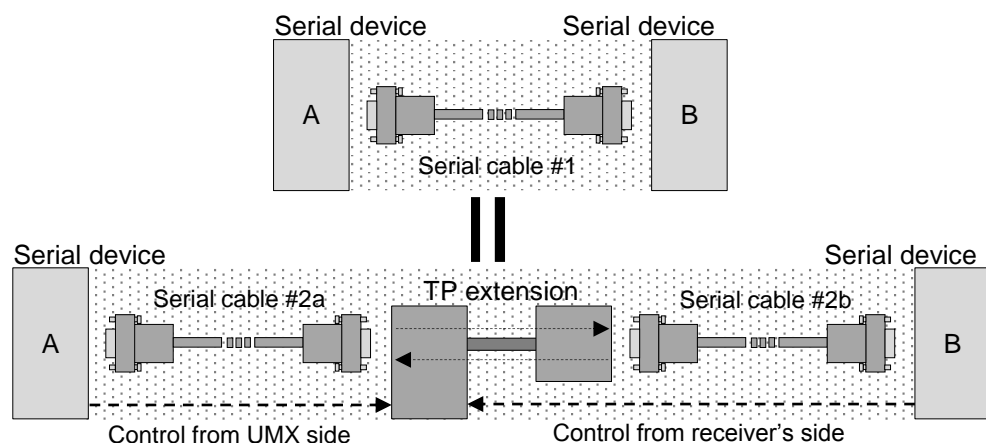

Figure 5-1. Connecting serial devices

5.5. Operation modes

There are two kinds of operations for the unit regarding the serial port: you can control the unit or use the bidirectional serial link through the DDC CAT cable with a compatible HDMI-TP receiver.

5.5.1. Control mode

In the first case the CPU in the transmitter can receive commands and send responses either to and from the own serial port or to and from the serial port on the receiver unit through the DDC line (2nd CAT cable).

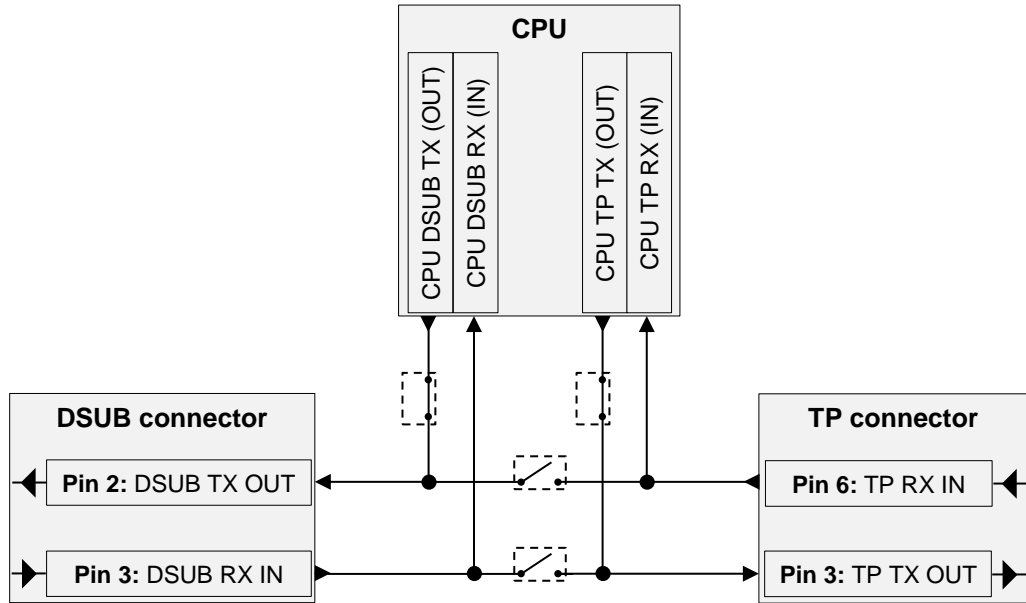

Figure 5-2. UMX-TP-TX100R in control mode

5.5.2. Pass-through mode

In case of the second mode the TX lines of the processor are in HiZ state and the serial connectors on the transmitter and on the receiver are linked together through the DDC CAT cable.

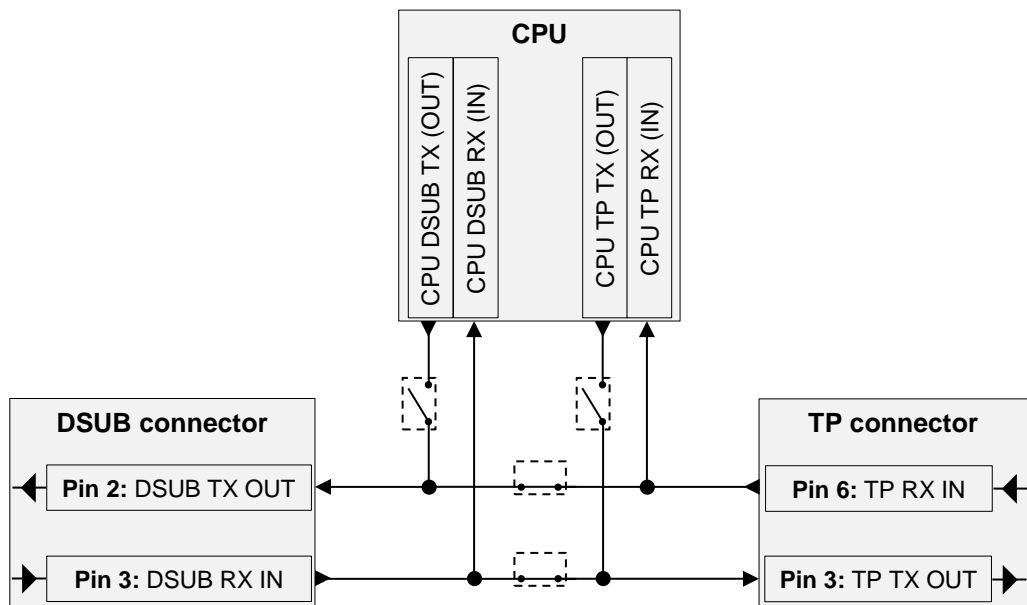
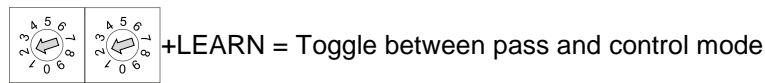

Figure 5-3. UMX-TP-TX100R in pass-through mode

5.5.3. Changing the working mode

Turn both of the rotary switches to address #2, and press and hold the LEARN button for approximately 3 seconds.



The status change appears on the LED tower. If the working mode becomes pass-through the LEDs flash from top to bottom sequentially. If the working mode becomes control the LEDs flash from bottom to top sequentially.

Changing the working mode can be done by protocol command (section 8.4.5 on page 57) or the Lightware Matrix Controller software (section 7.3.2 on page 41).

Info: UMX-TP-TX100R stores the RS-232 working mode and starts the saved one after reboot.

The default baud rate for control is 57600, the command to set the baud rate can be the following: 9600, 19200, 38400, 57600 and 115200.

Of course in PASS mode the speed can be anything, but for changing and querying the mode the previously set baud rate must be applied for the sent commands.

For more information see section 8.4.2 on page 56.

5.5.4. Detailed example:

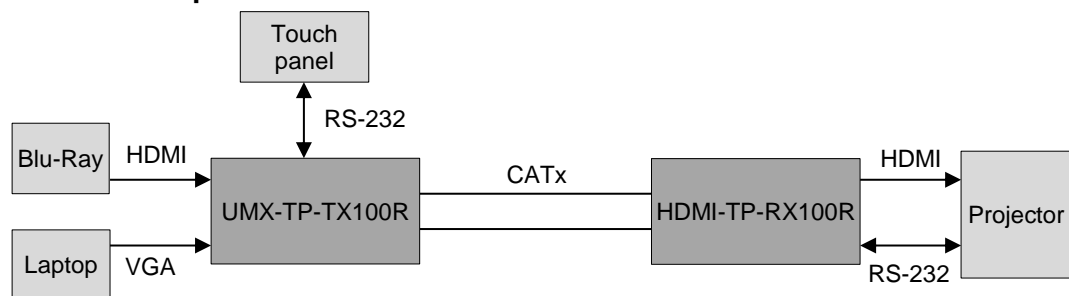

Figure 5-4. Example system diagram

The system consists of the following: a Blu-Ray player and a laptop as sources, a programmable touch panel as a controller, then a Lightware UMX-TP-TX100R and HDMI-TP-RX100R as the TP extenders, then a projector as a sink device. The touch panel has three buttons. The desired functions of the buttons are that they can power on and off the projector, and switch between the inputs. Let's examine the detailed solution.

Three types of the touch panel's commands:

- (): settings of the touch panel / not sent /
- []: command to the projector / sent via RS-232 /
- { }: command to the UMX-TP-TX100R / sent via RS-232 /

Initializing:

First of all the touch panel can control the projector only if RS-232 settings are the same for the touch panel and the projector.

```
Commands:           Comments:
(set_RS-232)        /* Set the appropriate RS-232 settings which are fit to
                    the UMX-TP-TX100R and the projector as well. */
```

Button 1 (Power on the projector):

The touch panel can control the projector only if the UMX-TP-TX100R is in pass-through mode.

```
{RS232=PASS}        /* Set the UMX-TP-TX100R in pass-through mode */
[projector_on]      /* Power on the projector */
```

Button 2 (Select the HDMI input):

The touch panel can only control the UMX-TP-TX100R if that is in control mode.

```

Commands:           Comments:

{RS232=CONTROL}    /* Set the UMX-TP-TX100R in control mode */
{1@1 AV}           /* Select the HDMI input on the UMX-TP-TX100R */
    
```

Button 3 (Power off the projector):

The touch panel can control the projector only if the UMX-TP-TX100R is in pass-through mode.

```

Commands:           Comments:

{RS232=PASS}       /* Set the UMX-TP-TX100R in pass-through mode */
[projector_off]    /* Power off the projector */
    
```

5.6. Powering device

Warning!

When building an electronic system, make sure that all of the devices are powered down before connecting them. Powered on devices may have dangerous voltage levels that can damage sensitive electronic circuits.

UMX-TP-TX100R doesn't have any jumper, because the power supply is automatic. User must handle the receiver's power settings only. Please read out carefully the receiver unit user's manual for the appropriate jumper settings.

Figure 5-5. shows the most frequently power settings of the receivers with the UMX-TP-TX100R transmitter.

Warning!

Please check the receivers' power settings before they are switched on.

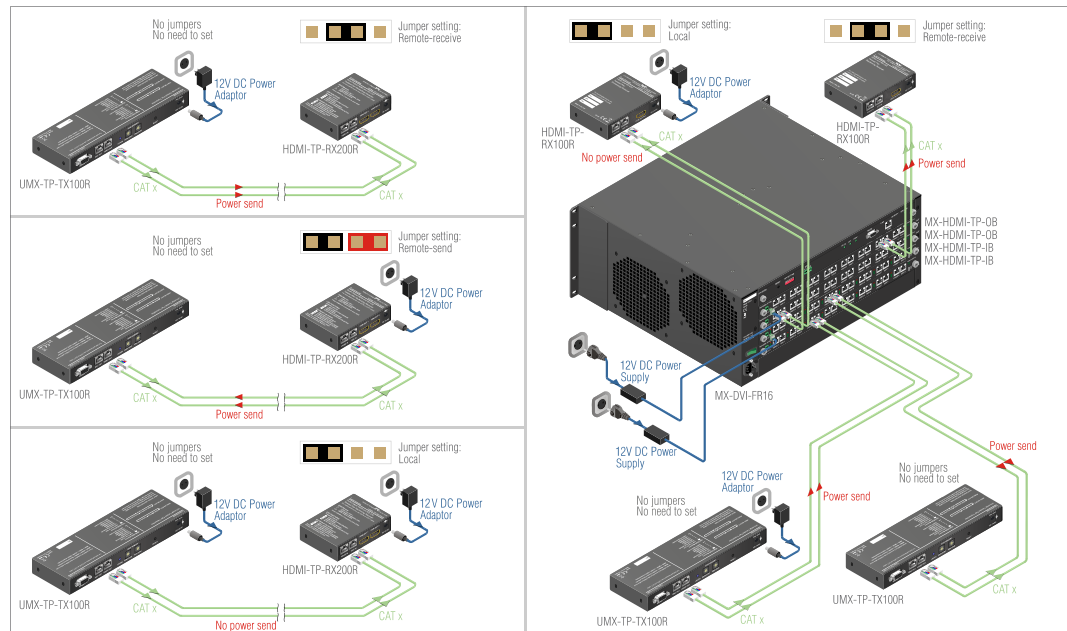

Figure 5-5. Power settings

5.6.1. Boot up of HDMI-TP extender units

After all the other connections in the system are complete, connect the output of the +12V Power Adaptor to the UMX-TP-TX100R.

The special locking DC plug provides safe connection. Plug the connector into the +12V 1A DC IN receptacle and twist 90° clockwise to lock it. Plug the adaptor into the electric outlet. The unit is immediately powered ON.

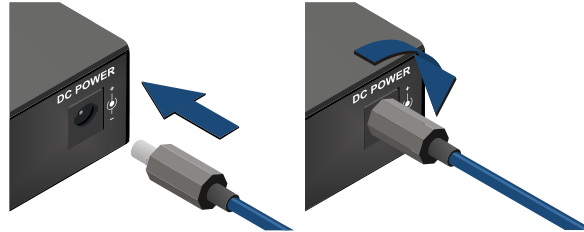

Figure 5-6. Locking DC plug

After being powered on, the UMX-TP-TX100R lights up all LEDs, then displays its firmware version using the three upper front panel LEDs. The top LED means the first number of the firmware version, actually this is the main version. From the top the second and the third LEDs mean the second and the third number of the firmware version, actually these are the subversions.

The following example shows this process for a firmware version of 1.0.9

The top LED blinks once → Short pause → The second LED does not blink, this means the number 0 → Short pause → The third LED blinks nine times → Short pause → The normal function of the LED is in effect.

After indicating the firmware version, UMX-TP-TX100R checks the video output: reads the EDID if there is a Hot Plug signal and authenticates devices in case of HDCP encryption. This procedure takes approximately 5 seconds.

UMX-TP-TX100R stores the video and audio crosspoint state in a non-volatile memory and after booting it starts with it.

After the UMX-TP-TX100R is initialized, the attached source(s), receiver pair and monitor(s) can be powered on.

Info

If none of the LEDs light up upon power-up, the unit is most likely damaged and further use is not advised. Please contact support@lightware.com

6. Operation of UMX-TP-TX100R

6.1. Front panel LEDs

To save space and simplify readability UMX-TP-TX100R uses only four LEDs to inform the users about the connections, crosspoint state, the video signals and so on. Because of the low numbers of LEDs several functions are used to display information.

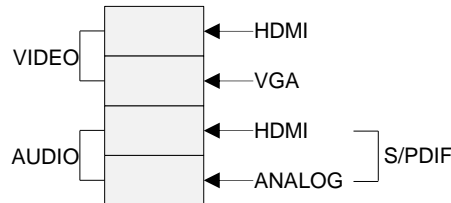

Figure 6-1. Legend of the LED bar

Firmware indication

After being powered on, the UMX-TP-TX100R lights up all LEDs, then displays its firmware version using the three upper front panel LEDs.

After being powered on, the UMX-TP-TX100R lights up all LEDs, then displays its firmware version using the three upper front panel LEDs. The top LED means the first number of the firmware version, actually this is the main version. From the top the second and the third LEDs mean the second and the third number of the firmware version, actually these are the subversions.

The following example shows this process for a firmware version of 1.0.9

The top LED blinks once → Short pause → The second LED does not blink, this means the number 0 → Short pause → The third LED blinks nine times → Short pause → The normal function of the LED is in effect.

Signal state in DIRECT SELECT mode

VIDEO

If there is a valid incoming video signal on the selected video input port (e.g. HDMI) the corresponding LED (HDMI VIDEO) lights continuously. If the video input port is selected but there is no valid incoming video signal, the corresponding video LED blinks continuously.

AUDIO

If the HDMI or VGA audio input port is selected the HDMI or ANALOG AUDIO LED lights continuously. If the S/PDIF audio input port is selected both of the AUDIO LEDs (the HDMI and the ANALOG AUDIO LED together) lights continuously.

Signal state in AUTOSELECT mode

VIDEO

If there is no incoming video signal on either of the video input ports the device searches active video sources. During this process the HDMI VIDEO and the VGA VIDEO LEDs blink alternately and AUDIO LEDs are off. If an active video signal was found and selected the corresponding VIDEO LED lights up.

AUDIO

During the searching process the AUDIO LEDs are off. If the HDMI or VGA audio input port is selected the HDMI or ANALOG AUDIO LED lights continuously. If the S/PDIF audio input port is selected both of the AUDIO LEDs (the HDMI and the ANALOG AUDIO LED together) lights continuously.

EDID management

Successful EDID learning

All the four LEDs blink 3 times in 3 seconds. (slow blinking)

Unsuccessful EDID learning

All the four LEDs blink 15 times in 2 seconds. (fast blinking)

Entering autoselect mode

The HDMI and VGA LEDs blink alternately for 3 seconds while audio LEDs are off.

6.2. Input selection

Video and Audio input can be chosen with:

VIDEO and AUDIO SELECT button on the front panel

AUTOSELECT mode

Lightware Matrix Controller software (section [7.3.1](#) on page [41](#))

Protocol command (section [8.6.1](#) on page [64](#))

6.2.1. VIDEO INPUT selection

The order of the video selection is shown on the Figure 6-2. After the VIDEO SELECT button was pushed, the next input will be chosen. The corresponding LED lights up.

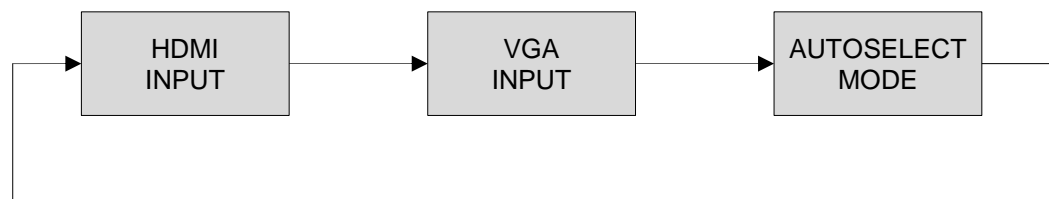

Figure 6-2. Video input selection order

6.2.2. AUDIO INPUT selection

The order of the audio selection is shown on the Figure 6-3. After the AUDIO SELECT button was pushed, the next input will be chosen. The corresponding LED lights up.

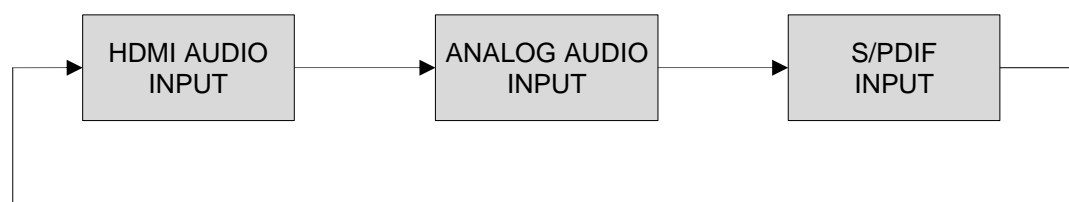

Figure 6-3. Audio input selection order

6.2.3. AUTOSELECT mode

The Autoselect function means UMX-TP-TX100R can recognize the incoming valid video signals on both input ports and can choose one automatically, without user intervention.

The AUTOSELECT mode can work in two ways:

- **Non-priority (first detect):** The device checks the HDMI input first. If there is a valid video signal on the HDMI input it will be selected. If there is no video signal on the HDMI input the device checks the VGA input. If there is a valid video signal on the VGA input it will be selected. If there is no video signal on the VGA input neither the searching process starts again.

If the selected input was unplugged or the valid video signal was disappeared the searching process starts again.

If one input port (e.g. VGA) was selected - and there is a valid video signal on it - and a valid video signal was appeared on the other input port (HDMI) – by connecting or powering on a video source - the searching process does NOT start again. The previous selected video input port (VGA) remains the active one.

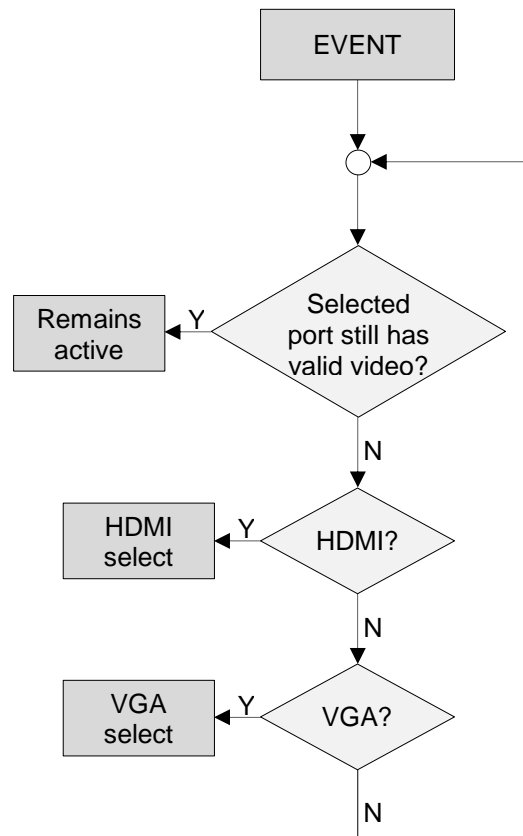

Figure 6-4. Non-priority video selection flowchart

- **Priority:** The device checks the HDMI input first. If there is a valid video signal on the HDMI input it will be selected. If there is no video signal on the HDMI input the device checks the VGA input. If there is a valid video signal on the VGA input it will be selected. If there is no video signal on the VGA input neither the searching process starts again.

If the selected input was unplugged or the valid video signal was disappeared the searching process starts again.

If one input port (e.g. VGA) was selected - and there is a valid video signal on it - and a valid video signal was appeared on the other input port (HDMI) – by connecting or powering on a video source - the searching process STARTS AGAIN with checking the HDMI input. The previous selected video input port (VGA) becomes inactive and the privileged one (HDMI) becomes active.

In brief in case of incoming valid HDMI video signal on the HDMI input, it will always be selected even if there was an earlier selected VGA video signal.

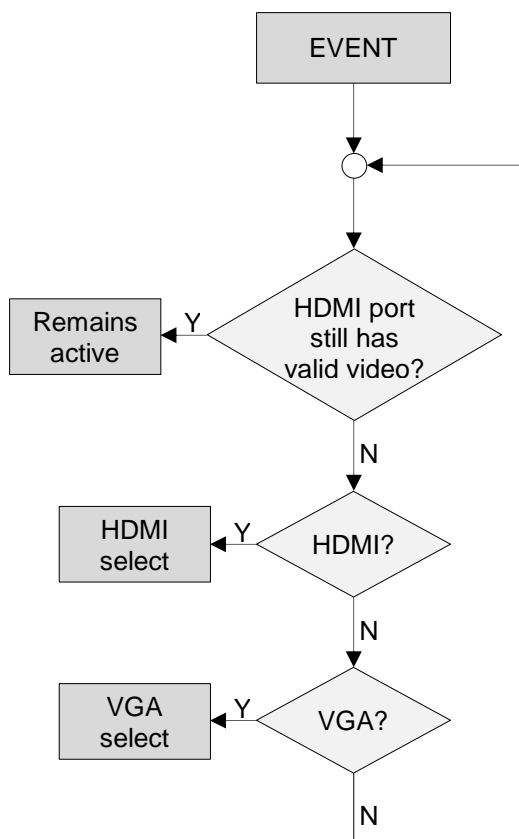

Figure 6-5. Priority video selection flowchart

User can toggle between the two AUTOSELECT priority modes with protocol command. For more information see chapter [8.4.13](#) on page [59](#).

6.2.4. Audio input in AUTOSELECT mode

The AUDIO input selection is linked to the VIDEO input selection in the AUTOSELECT mode:

If there is no video signal neither HDMI nor VGA input the device checks the S/PDIF audio input. If there is valid S/PDIF audio signal on the S/PDIF input port this port will be selected. If there is no S/PDIF audio the device checks the analog audio input. If there is valid analog audio signal on the analog input port this port will be selected. If there is no analog audio the searching process starts again.

If there is a valid incoming HDMI video signal on the HDMI input port the device checks the HDMI embedded audio input. If there is valid embedded HDMI audio signal on the HDMI input port this port will be selected. If there is no embedded HDMI audio the device checks the S/PDIF audio input. If there is valid S/PDIF audio signal on the S/PDIF input port this port will be selected. If there is no S/PDIF audio the device the analog audio input will be selected.

If there is a valid incoming VGA video signal on the VGA input port the device checks the S/PDIF audio input. If there is valid S/PDIF audio signal on the S/PDIF input port this port will be selected. If there is no S/PDIF audio the device the analog audio input will be selected.

To better understand the audio input selection in autoselect mode please study the below diagram.

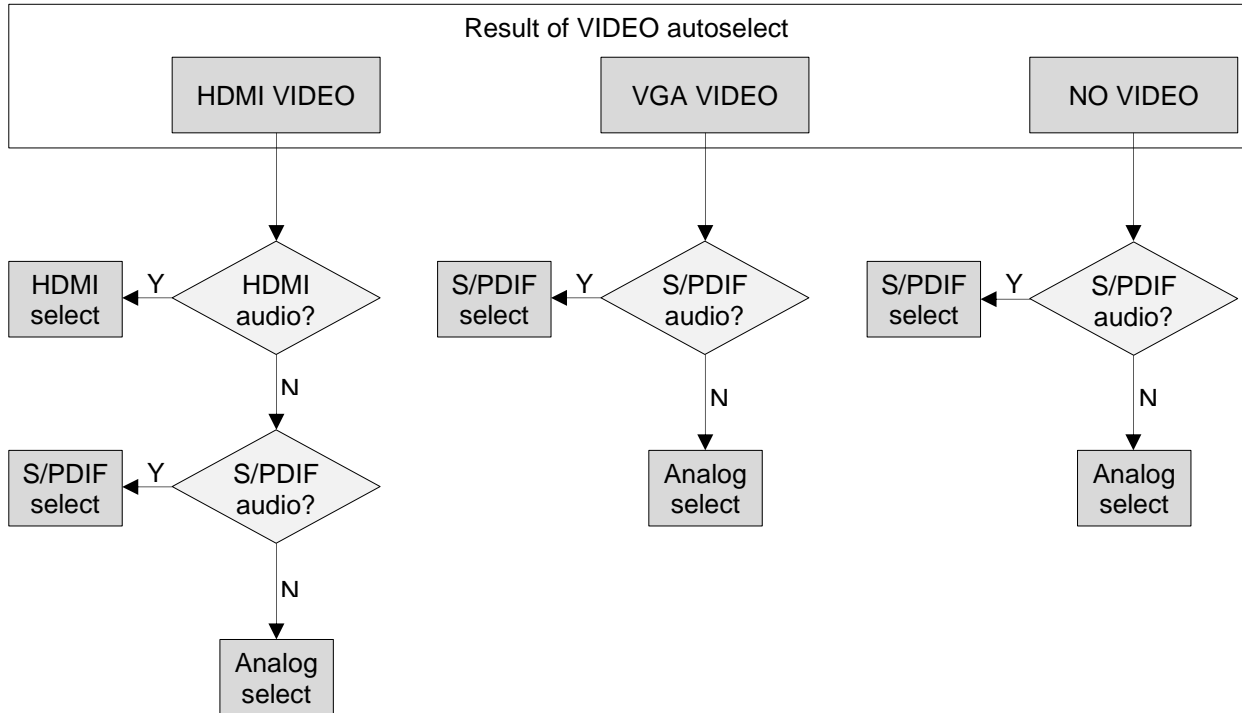

Figure 6-6. Audio input selection order in AUTOSELECT mode

6.3. About EDID memory

EDID memory is non-volatile and consists of four blocks, each for different purpose. These blocks are:

- Factory preset EDIDs
- User saved EDIDs
- Dynamic EDID (EDID of last connected sink on the DDC output port)
- Emulated EDIDs (EDID currently emulated on a specific input port)

This manual refers to the EDIDs in two ways:

6.3.1. EDIDs are referred with Lightware Matrix Controller

In the first case EDID is mentioned with the Matrix Controller software or the protocol commands. EDIDs are numbered from 1 in each block, and they can be referred as the first letter of the block name, and the number of the desired EDID. This way F02 refers to the second factory preset EDID, and D01 refers to the display device's EDID on the output (on the receiver's output).

The EDID memory structure in protocol reference:

Factory Preset EDIDs (F01 .. F10):

F01 .. F05HDMI Factory Preset EDIDs
 F06 .. F10 VGA Factory Preset EDIDs

User programmable memories (U01 .. U08):

U01 .. U04User programmable HDMI memories
 U05 .. U08User programmable VGA memories

Last attached monitor's EDID: (D01):

D01Last attached monitor's EDID on the output
 E01 Emulated EDID on the HDMI input

Emulated EDIDs (E01 .. E02):

E01 .. E02Emulated EDIDs on the VGA input

6.3.2. EDIDs are referred with rotary switches

In the second case EDID is mentioned with the rear panel rotary switches. EDIDs are numbered from 0 on each rotary, and they can be referred with hash symbol, and the number of the desired EDID. This way #6 refers to the first user preset EDID, and #0 refers to the display device's EDID on the output (on the receiver's output).

The EDIDs can be chosen by rotary switches:

| HDMI EDID rotary | | VGA EDID rotary | |
|------------------|---------------------------------------|-----------------|--------------------------------------|
| #0 | Copy from TP OUT (Dynamic EDID) | #0 | Copy from TP OUT (Dynamic EDID) |
| #1 | FACTORY EDID Universal HDMI (default) | #1 | FACTORY EDID Universal VGA (default) |
| #2 | FACTORY EDID (DVI) 1024x768@60 | #2 | FACTORY EDID 1024x768@60 |
| #3 | FACTORY EDID (HDMI) 1280x720p@60 | #3 | FACTORY EDID 1280x720@60 |
| #4 | FACTORY EDID (HDMI) 1920x1080p@60 | #4 | FACTORY EDID 1920x1080@60 |
| #5 | FACTORY EDID (DVI) 1920x1200@60 | #5 | FACTORY EDID 1920x1200@60 |
| #6 | USER EDID 1 (def.: Univ. HDMI EDID) | #6 | USER EDID 1 (def.: Univ. VGA EDID) |
| #7 | USER EDID 2 (def.: Univ. HDMI EDID) | #7 | USER EDID 2 (def.: Univ. VGA EDID) |
| #8 | USER EDID 3 (def.: Univ. HDMI EDID) | #8 | USER EDID 3 (def.: Univ. VGA EDID) |
| #9 | USER EDID 4 (def.: Univ. HDMI EDID) | #9 | USER EDID 4 (def.: Univ. VGA EDID) |

6.3.3. The assigning table

To help understand the EDID memory structure see the matching table below. It shows all the EDIDs, their short descriptions and their references.

| Number on HDMI EDID rotary | EDIDs for HDMI Input | EDID reference in protocol |
|----------------------------|---------------------------------------|----------------------------|
| #0 | Copy from TP OUT (Dynamic EDID) | D0 |
| #1 | Factory EDID Universal HDMI (default) | F1 |
| #2 | Factory EDID (DVI) 1024x768@60 | F2 |
| #3 | Factory EDID (HDMI) 1280x720p@60 | F3 |
| #4 | Factory EDID (HDMI) 1920x1080p@60 | F4 |
| #5 | Factory EDID (DVI) 1920x1200@60 | F5 |
| #6 | User EDID (def.: Univ. HDMI EDID) | U1 |
| #7 | User EDID (def.: Univ. HDMI EDID) | U2 |
| #8 | User EDID (def.: Univ. HDMI EDID) | U3 |
| #9 | User EDID (def.: Univ. HDMI EDID) | U4 |

| Number on VGA EDID rotary | EDIDs for VGA Input | EDID reference in protocol |
|---------------------------|--------------------------------------|----------------------------|
| #0 | Copy from TP OUT (Dynamic EDID) | D0 |
| #1 | Factory EDID Universal VGA (default) | F6 |
| #2 | Factory EDID 1024x768@60 | F7 |
| #3 | Factory EDID 1280x720@60 | F8 |
| #4 | Factory EDID 1920x1080@60 | F9 |
| #5 | Factory EDID 1920x1200@60 | F10 |
| #6 | User EDID (def.: Univ. VGA EDID) | U5 |
| #7 | User EDID (def.: Univ. VGA EDID) | U6 |
| #8 | User EDID (def.: Univ. VGA EDID) | U7 |
| #9 | User EDID (def.: Univ. VGA EDID) | U8 |

All EDIDs (including factory presets; user programmable memories and EDID at TP output) can be switched and emulated at any of the inputs.

Info: The factory EDIDs (Fxx) are factory preprogrammed and cannot be modified. These are the most commonly used resolutions.

Info: UMXTP-TX100R can handle both 128 Byte EDID and 256 Byte extended EDID structures.

Info: The attached monitor's EDID is stored automatically, until a new monitor is attached to that particular output. In case of powering the unit off, the last attached monitor's EDID remains in non-volatile memory even is the monitor is unconnected.

Warning! Emulated EDIDs can be switched with the rotary switches only.

6.4. EDID types

Most of the factory preset EDIDs include only one resolution. This is to force the connected source to give a signal with the needed resolution. However there are Universal EDIDs as well which allow many resolutions.

The factory EDIDs are divided into groups regarding their type. Some EDIDs are supporting DVI only, some support HDMI, and some are for analog VGA signals.

Analog EDIDs can be used for VGA (RGBH) input port.

DVI EDIDs does not support embedded audio.

HDMI EDIDs support embedded audio. These EDIDs – include Universal HDMI EDID - indicate that any audio format is accepted (PCM, Dolby, DTS, etc.).

Info: Analog and HDMI user EDIDs are the Universal Analog and HDMI EDIDs in factory defaults.

6.4.1. Factory preset EDID list

Lightware factory pre-loaded EDIDs are specially provided to force graphic cards to output only the exact pixel resolution and refresh rate.

HDMI and VGA universal EDIDs (#1 on both rotary switches) allow multiple resolutions including all common VESA defined resolutions. In addition, HDMI universal EDID also features audio support. The use of universal EDID is recommended for fast and easy system setup.

| Mem. | Resolution | Type | Audio support | | Deep color support | | |
|------------|--------------------------|--------|---------------|-------|--------------------|--------|--------|
| | | | PCM | Other | 24 bit | 30 bit | 36 bit |
| F01 | Universal_HDMI_DC | HDMI | ✓ | ✓ | ✓ | x | ✓ |
| F02 | 1024 x 768 @ 60.0 Hz | DVI | x | x | x | x | x |
| F03 | 1280 x 720 @ 60.0 Hz | HDMI | ✓ | x | ✓ | x | x |
| F04 | 1920 x 1080 @ 60.0 Hz | HDMI | ✓ | x | ✓ | x | x |
| F05 | 1920 x 1200 @ 59.55 Hz | DVI | x | x | x | x | x |
| F06 | Universal_Analog | Analog | x | x | x | x | x |
| F07 | 1024 x 768 @ 60.0 Hz | Analog | x | x | x | x | x |
| F08 | 1280 x 720 @ 60.0 Hz | Analog | x | x | x | x | x |
| F09 | 1920 x 1080 @ 60.0 Hz | Analog | x | x | x | x | x |
| F10 | 1920 x 1200 @ 59.55 Hz | Analog | x | x | x | x | x |

Table 6-1. Factory Preset EDID list

Info: The first 10 EDID (#1..#10 inclusive) are factory preprogrammed and cannot be modified. These are the most commonly used resolutions.

6.5. Learning the EDID

The factory preset EDIDs cannot be changed by the user. Only addresses #6 .. #9 (on both rotary switches) are user programmable.

Important! EDID learning is only available from the active input to a user memory location which was selected by a rotary switch. EDID learning is not allowed in AUTOSELECT mode.

Info: Before a digital EDID will be saved into a VGA memory location UMX-TP-TX100R removes the digital descriptor from the EDID, and saves it.

After connecting the sink device to the unit's output (for example the receiver unit's HDMI OUT), use a screwdriver to select an empty memory address. EDIDs are stored in a multiple programmable non-volatile memory.

Push the LEARN button on the front side of the device and hold it down for approximately 3 seconds.

If the EDID storing was successful, all the status LEDs blink 3 times in 3 seconds slowly then they return to their original function.

If the storing was unsuccessful, all the status LEDs blink 15 times in 2 seconds quickly then they return to their original function.

Info: The last attached monitor's EDIDs are stored automatically, until a new monitor is attached to the output (or receiver's output). In case of powering the unit off, the last attached monitor's EDID remains in non-volatile memory.

Info: As a matter of fact UMX-TP-TX100R always learns the stored last attached monitor's EDID into the user programmable EDID memory. If the attached sink device on the output is unplugged pushing and holding the LEARN EDID button causes a successful EDID learning without plugging in the monitor again. (even after a power reset)

6.6. Switching the EDID

Use a screwdriver to change the memory address on the rear side of the UMX-TP-TX100R.

After either one of the rotary switches has been rotated, the unit waits approximately 2 seconds before the selected EDID becomes active.

The address #0 (on both rotary switches) has a special function. If a receiver is connected to the output, then its EDID is copied to the input connector. If no receiver is connected to the output then the EDID transmitted to the input connector is the EDID of the last connected monitor.

Info: If an invalid EDID is selected, the UMX-TP-TX100R does NOT give a HOT PLUG signal to the input (HDMI or VGA).

Info: After every EDID change, UMX-TP-TX100R toggles the HOT PLUG signal for approx. 1 second. Some graphic cards or DVD players do not sense the HOT PLUG signal, and even if EDID has been changed, the set resolution is not affected. In this case the source device must be restarted, or powered OFF and ON again.

Important! Switching EDID is available only with rotary switches. (Switching with Lightware Matrix Controller Software or protocol command is not available.)

6.7. Deleting the EDID

Only user EDIDs can be deleted. Deleting means the factory EDID (Universal HDMI or Analog EDID) will be loaded into the desired user EDID memory.

6.8. Invalid EDID on any input

Invalid EDID doesn't occur under normal operation. If it does occur due to unexpected circumstances status LEDs indicate it with the following method:

If an input port (HDMI or VGA) was selected by user or autoselect where invalid EDID is, the affected port's status LED (HDMI or VGA) lights continuously and the audio LEDs (HDMI Audio and Analog Audio) blink together.

6.9. HDCP management

The UMX-TP-TX100R can work as a HDCP compliant device, or act as a non-HDCP compliant sink. The HDCP capability can be disabled or enabled on the digital video input port. This function helps to apply encryption only when it is mandatory.

Some video sources send encrypted signal when they are connected to a HDCP capable device even if the content is not protected. This way even the unprotected content cannot be displayed on non-HDCP displays if the signal travels through a HDCP compliant matrix or repeater.

However HDCP encryption is not required all the time (e.g. computer desktop image) some video cards still encrypt if they detect that the sink is HDCP capable.

Avoiding unnecessary HDCP encryption

If HDCP is disabled on the digital video input port, the connected source will detect that the sink is not HDCP capable, and turn off authentication. The source will not be able to communicate with any of the devices (displays, repeaters, etc.) that are connected to the receiver's output, therefore it could not see if they are HDCP capable or not.

This forces the source to send unprotected signal only. If HDCP capability is disabled on an input port, the connected source cannot send protected content to any display. If HDCP function is enabled on an input port and the source sends encrypted signal, the non-HDCP compliant devices cannot display the video.

Info:

In HDCP disable mode, protected content (i.e. Blu-ray disc) will not be displayed, thus maintaining the rules set by the HDCP standard.



To toggle the HDCP function, use Matrix Controller software (see section [7.3.3](#) on page [41](#)), use protocol command (see section [8.8.1](#) on page [67](#)), or turn both of the rotary switches to address #1, and press and hold the LEARN button for approximately 3 seconds.

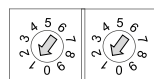

+LEARN = HDCP enable / disable

The status change appears on the LED tower. If HDCP is disabled the LEDs flash from top to bottom sequentially. If HDCP is enabled the LEDs flash from bottom to top sequentially.

HDCP key counter

HDCP key counter is a tool that counts and validates the number of keys that can be accepted by a source device when connected to an HDCP repeater.

HDCP key counting is available with protocol command. For more information, see section [8.4.7](#) on page [57](#).

6.10. No sync color

The device generates a solid 640x480 resolution image when there is no incoming signal. The color of this picture can be set in the Lightware Matrix Controller software (section [7.3.3](#) on page [41](#)) or with protocol command (section [8.8.12](#) on page [73](#)).

6.11. Hardware reset

If any malfunction is noticed and the device does not respond it can be necessary to have a hardware reset. Push and release the reset button to restart the device.

This process can be induced by protocol command as well. For more information see section [8.4.9](#) on page [58](#).

Info: Saved settings and EDIDs will be remained after the reboot.

6.12. Reload factory defaults

Factory default settings can be reloaded with the procedure below:

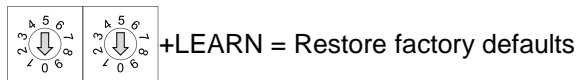

Turn both of the rotary switches to address #0, and press and hold the LEARN button for approximately 3 seconds.

After restoring default values the device reboot automatically.

This operation affects the crosspoint table and configuration, input and output names, I/O settings and stored User and Dynamic EDIDs.

Warning! User and Dynamic EDIDs will be cleared (refilled with Lightware Universal EDID) after reloading the factory defaults.

Warning! Reloading factory defaults by rotary switches plus learn button AFFECTS the serial operation mode and the RS-232 baud rate options as well. The default operation mode is the CONTROL mode and the default baud rate is 57600 baud in the UMX-TP-TX100R. If the previous serial settings differ from the default ones, please set up the necessary values after reboot with protocol commands. (Set the RS-232 operation mode command in section [8.4.5](#) on page [57](#) and the Change RS-232 baud rate command in section [8.4.2](#) on page [56](#))

This process can be induced by protocol command as well, but reload factory defaults by protocol command does NOT AFFECTS the serial operation mode and the baud rate options. For more information see section [8.4.4](#) on page [56](#).

7. Software control – Using the Lightware Matrix Controller

The device can be controlled using the Lightware Matrix Controller from a Windows PC or Laptop through RS-232 port.

7.1. Installing the Matrix Controller software

Step 1. Run Installer_LW_matrix_controller_v3_4_2.exe

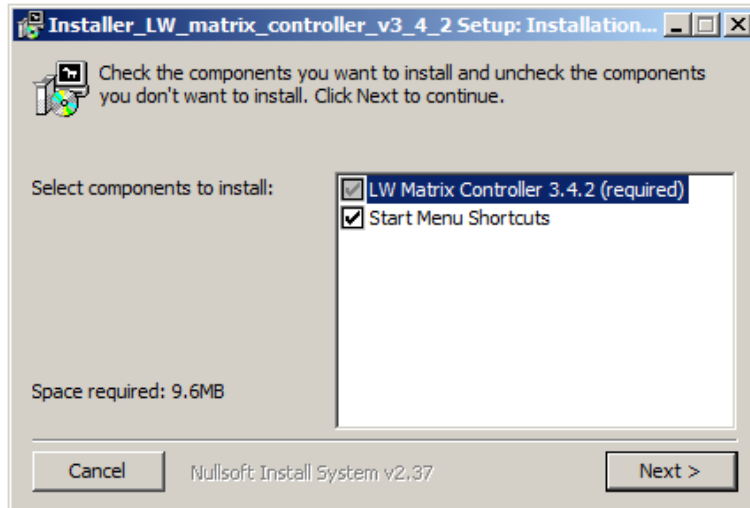

Step 2. Select destination folder and click Install (Using the default path is highly recommended)

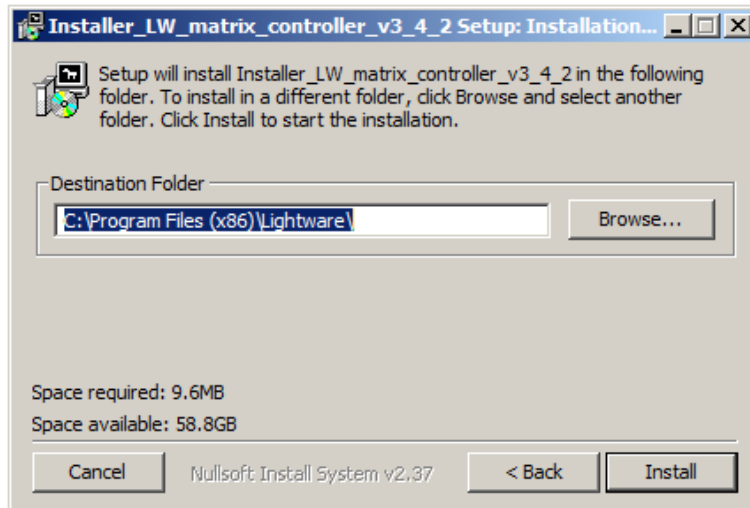

Step 3. If you want to create desktop icon click Yes in the next pop-up window:

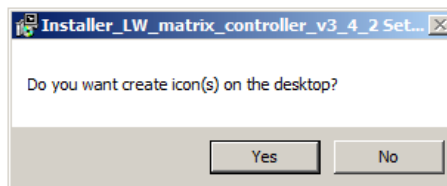

Step 4. After finishing the installation the following message appears:

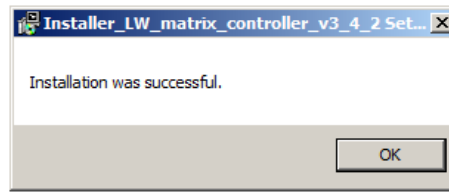

Step 5. To run Lightware matrix control software find the shortcut icon in Start menu → Programs → Lightware → LW_matrix_controller_v3.4.2 or on the desktop, and double click:



Uninstalling

To uninstall the control software double click on: Start menu → Programs → Lightware → LW_matrix_controller_v3_4_2 → Uninstall

7.2. Establishing the connection

The unit can be controlled from a Windows computer using Lightware Matrix Controller software through RS-232 connection.

Info:

Lightware Matrix Controller can works with two baud rates: 9600 Baud or 57600 Baud. The software is able to recognize and set the appropriate baud rate from the two values mentioned above, but these values cannot set or changed by the user. If the computer has different serial communication settings (e.g. 19200 Baud) the Matrix Controller software cannot connect to the device.

Step 1. Connect the device and the computer via serial port, with RS-232 Male to Female cable (straight through).



Step 2. Start the application

To run the CONTROL SOFTWARE double click on the icon of the software on the desktop or select proper shortcut from Start Menu → Programs → Lightware folder.

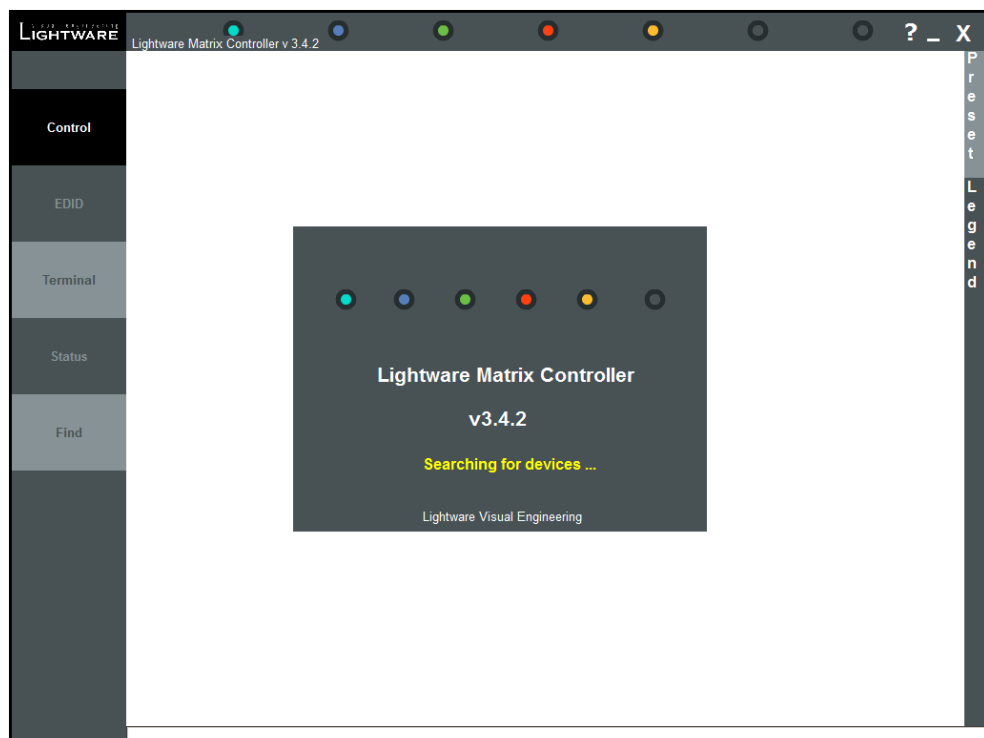

Figure 7-1. Matrix Controller software startup

Step 3. The Find dialog appears automatically

If the connection has been made via **serial port**, the device type and serial number can be inquired by double clicking the appropriate port, or it can be highlighted with a single click.

Info:

Lightware Matrix Controller software can only connect to the extender if it is in control mode. If the UMX-TP-TX100R is in pass-through mode, the software cannot communicate with it and cannot list it as an available device.

If you want to connect to the extender which is in pass-through mode click on the desired com port with the right mouse button, then choose the “Set RS-232 to CONTROL mode” option. The software sets the extender to CONTROL mode. Now the device can be listed with double left click on the discover window.

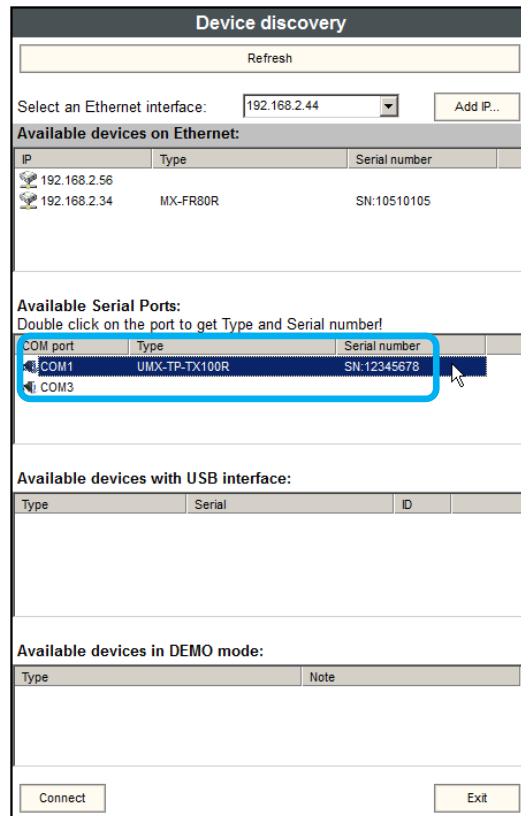
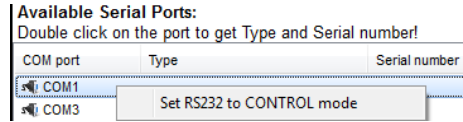

Figure 7-2. Serial connection

Step 4. Click on the Connect button to connect to the device

Info:

If the device is not listed, try searching again, or reconnect the device and restart the application.

When the Lightware Matrix Controller finds the hardware, it determines the product type, and the control menu appears. The current state of the crosspoint switch is displayed.

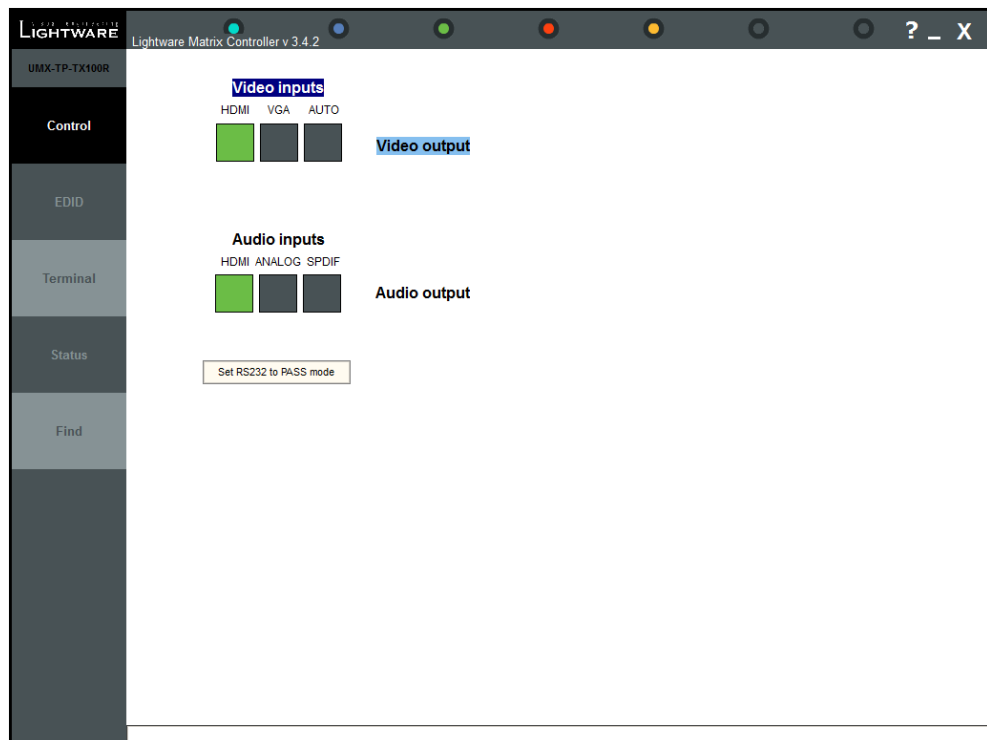

Figure 7-3. Matrix Controller crosspoint array

7.3. Control menu

This menu contains the crosspoint area. After connecting to a new device, this menu appears by default. This menu displays the current state of the device. Each green square represents an active connection between the inputs and the output. There can be only one green square in any row.

7.3.1. Switch

For making a connection click on the desired square. Video and audio signals can be switched independently.

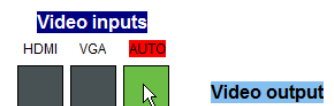

7.3.2. Toggle between the working modes

For changing the RS-232 working mode click on the button below:

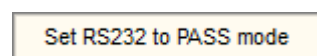

OR

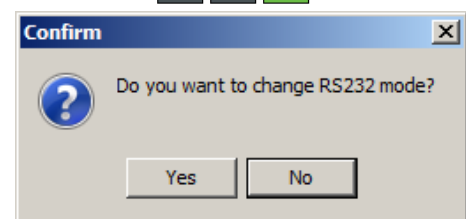
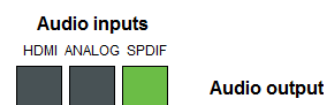
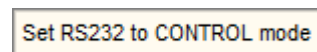

Click "Yes" in the confirmation window.

Warning!

If the device was set to pass-through mode it cannot communicate with the Lightware Matrix Controller software. Before any new command for the extender the control mode must be selected again.

7.3.3. Input parameter settings

By clicking on the video inputs a dialog window appears showing the parameters for the active input.

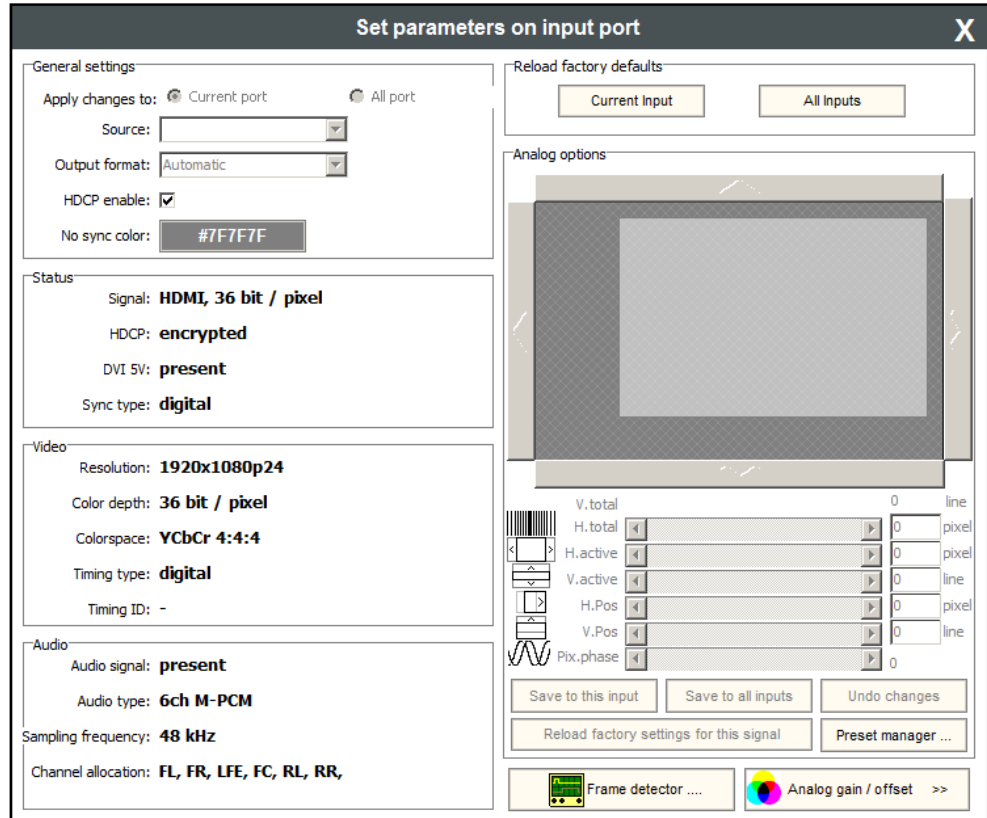

7-4. Input parameters for digital video signal

General settings

HDCP enable

The HDCP capability can be enabled or disabled on the input port with using the HDCP enable checkbox. This can prevent unnecessary HDCP encryption with certain source devices. Note that only unprotected content can be played on the source if this setting is disabled. For more information about HDCP handling see section 2.6 on page 12.

No sync color

The port generates a solid 640x480 resolution image when there is no incoming signal. The color of this picture can be set here. Double click on the colored field, a new window will appear. Choose the desired color then click the 'OK' button to apply changes. Click the Cancel button to discard changes and close the window.

Input port status

Connection status of the selected input port is shown here. (Type of the video signal, HDCP encryption, the source 5V, sync type)

Info: These fields are filled automatically by the matrix after the examination of the signal.

Video

Resolution, color depth and colorspace of the incoming signal are shown here.

The 'Timing type' and 'Timing ID' fields show which parameters are used to digitize the incoming analog signal. The input port measures the incoming analog signal and determines the timings. If the parameters need adjustment, it can be done on the right side at 'analog options'. In this case the 'Timing ID' field changes to 'user modified' unless the parameters are not saved.

Info: These fields are filled automatically by the matrix after the examination of the signal.

Audio

Information about the embedded audio signal is shown here. (Audio signal, audio type, sampling frequency, channel allocation)

Info: These fields are filled automatically by the matrix after the examination of the signal.

Reload factory defaults

Current input: Reloads the default values to the currently selected input.

All inputs: Loads the factory default values to all inputs.

Analog video options

Analog video signals are digitized on the input. The timing parameters can be adjusted here if needed. Timing presets can be saved for each resolution separately.

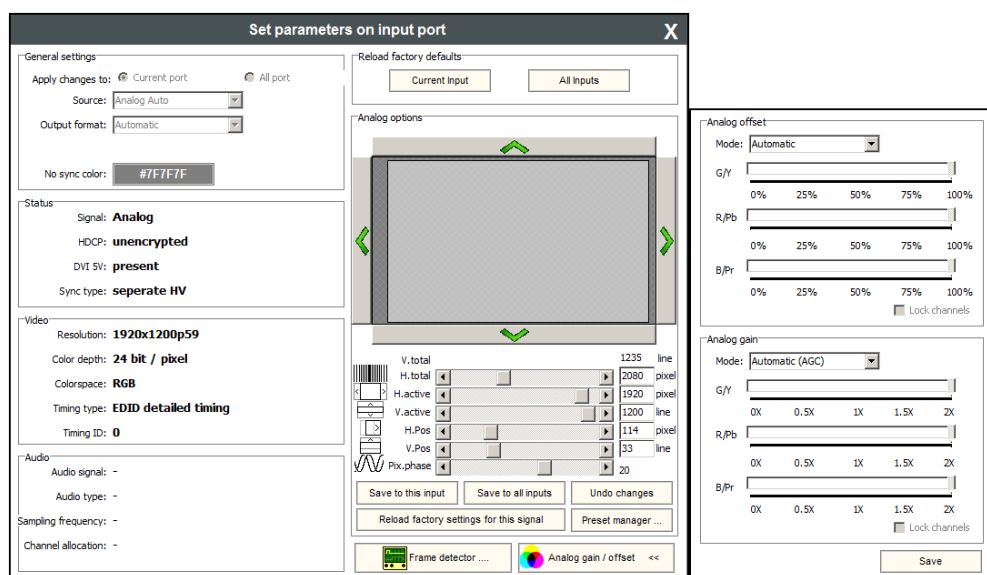

7-5. Input parameters for analog signal

Screen position

Screen position is an easy way to fit the visible area of the analog video signal and the sink device. Actually the horizontal and vertical positions (H.Pos and V.Pos) can be set with two different methods:

1. Click on the arrows to increase or decrease the H.Pos and V.Pos values,

OR

2. Move the mouse over the visible (grey) area. Click and hold with the left mouse button. Drag the visible area to the desired position.

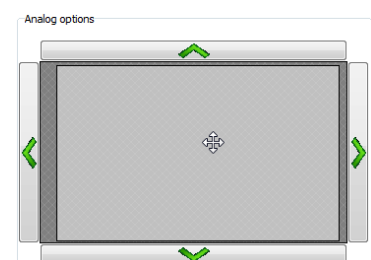

Analog video timings

V.total: Total line number of the whole image. (The visible and the blanking area)

H.total: Total pixel number of the whole image. (The visible and the blanking area)

H.active: Pixel number of the visible image.

V.active: Line number of the visible image.

H.Pos and V.Pos: Horizontal and vertical position values specify the location of the visible area on the sink device. Black border on any side of the picture can mean wrong settings for the position of the visible area.



Pix.phase: In case of unclear picture changing pixel phase can solve the problem. Changing the source device or the cable can cause pixel phase shifting.

Presets

User's settings for analog video timings can be set into the UMX-TP-TX100R as presets. One preset contains the following values which can be set by the user: H.active, V.active, H.pos, V.pos and Pix.phase.

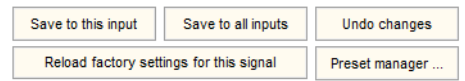

Presets can be assigned for each different resolution to the actual or to all inputs.

Save to this input: Preset assigned for the current resolution will be set to the actual input.

Save to all inputs: Preset assigned for the current resolution will be set to all inputs.

Undo changes: Backup the last saved preset values. If there were no saved values it sets up the original settings.

Reload factory settings for this signal: Clear the saved preset for this resolution from all the inputs, and sets up the original settings.

Preset manager

User can handle the saved values with the built-in preset manager. Click on the "Preset manager..." button and a new window will open. Presets are showed for the actual input port.

Delete record from this port: Delete the selected preset from only the current port.

Delete record from all ports: Don't need to open every preset manager for each input port to delete an unwanted preset. Just click the "Delete record from all ports" button. Never mind if the selected preset has different number in the other input properties list, because the device search by the current resolution.

Clone record to all port: Don't need to reload the saved values and save to all port. It can be done with only one step. Just select the desired preset and click the "Clone record to all port" button.

Columns: User can select which fields will be shown for the saved presets. The default fields are: Name, V.freq, H.freq, V.pos, H.pos, V.size, H.size and Phase.

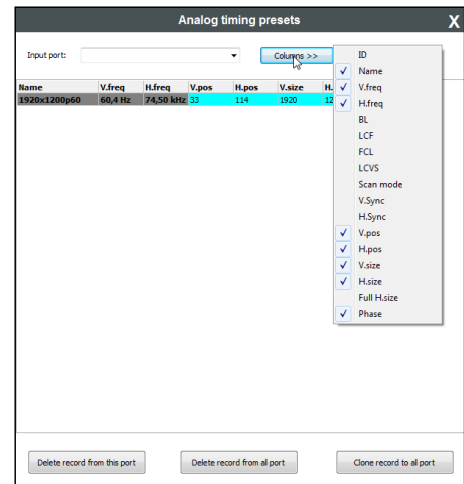

Info:

Analog timing presets can be saved only for the analog input port so „Delete record from all ports” and „Clone record to al port” buttons are kept for compatibility reasons.

Frame detector

Click the frame detector button to view the measured detailed timings on the incoming signal.

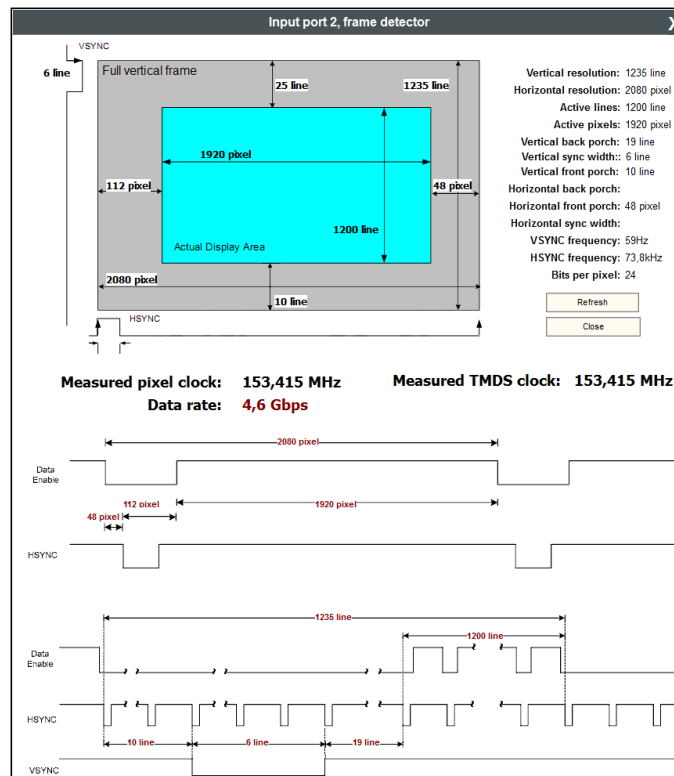

The dark grey zone is the blanking area (non-visible) and the cyan colored zone is the picture (visible area).

Info:

Resolution is given by the source devices always means the picture (visible area) resolution and the refresh rate means the VSYNC frequency.

If the Refresh button is clicked on then the UMX-TP-TX100R samples and calculates the analog signal values again.

Click on the Close button to close the Frame detector window and step back to the current input port settings window.

Analog gain / offset

Analog gain / offset window allows users to correct the gain and the offset values if the automatic mode doesn't give a good result. Gain and offset settings method are the same:

- Step 1.** Select the manual mode if the settings need to be changed.
- Step 2.** Tick the Lock channels if the three components might change with the same extent.
- Step 3.** Use the mouse to drag the slider and set to the desired position.
- Step 4.** Click on the Save button to store the changes.
- Step 5.** Click on the OK button when the confirmation message appears.
- Step 6.** Click on the Analog gain / offset button to close the window.

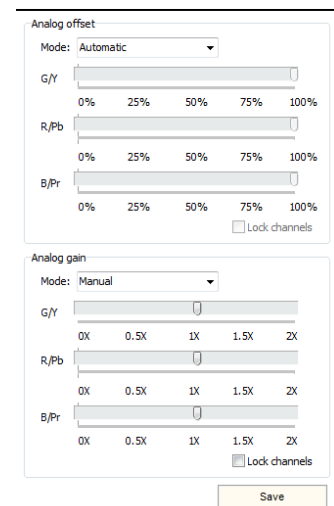

7.3.4. Output parameter settings

By clicking on the Video output label a dialog window appears showing the parameters for the corresponding output.

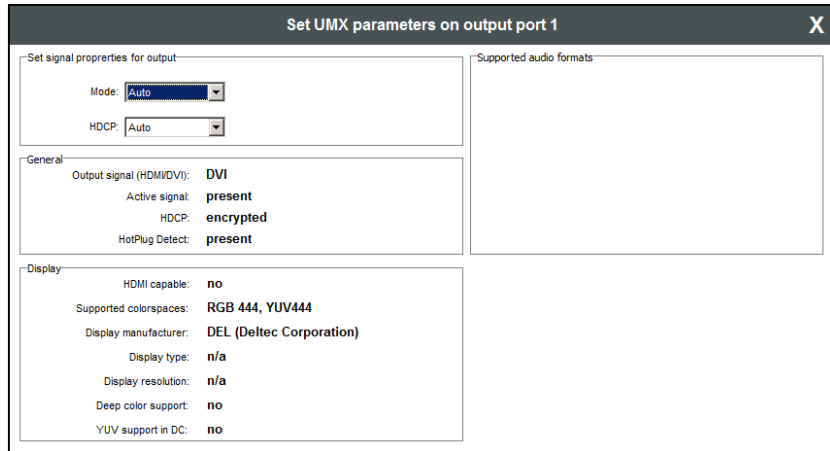

Output properties

Mode

The 'Mode' can be set to Auto, DVI, HDMI 24bit, HDMI 30bit or HDMI 36bit. The 'Auto' option sets the signal mode regarding to the attached display device's EDID and the incoming signal.

HDCP

The 'HDCP' option sets the HDCP encryption on the output. The Auto setting applies encryption when the incoming signal is encrypted. The Always setting forces encryption on any incoming video signal.

General

Information about the signal and the connection status is shown here.

Display

Information retrieved from the connected display's EDID is shown.

Supported audio formats

The connected display's supported audio formats are shown based on the read EDID.

7.4. EDID menu

Advanced EDID Management can be accessed by clicking on the EDID menu. This view is divided in two segments. The upper segment can be opened by clicking the green arrow. This segment contains the EDID editor. The lower segment is the EDID router area. This consists of two list windows, which can display a selected part of the EDID memory.

Info:

When the user enters the menu for the first time, the software starts to download the whole EDID list from the matrix. It may take about 30-40 seconds.

7.4.1. EDID Router operation

After the list is downloaded, the current status is shown. The EDID memory consists of four parts. Any memory part can be displayed on either side by using the drop down lists.

The **Emulated EDID List** shows the currently emulated EDIDs for each input. It contains the resolution, manufacturer and vendor name of the EDID reported to the sources for each input separately. The source column displays the memory location that the current EDID was routed from.

The **Last attached Monitor's EDID List** contains the resolution, manufacturer and vendor name of the display devices connected to matrix switcher's output. The matrix remembers the last display device's EDID, so there is an EDID shown even if there is no device attached to the router's output at the moment.

The **Factory EDID List** shows the factory memory locations (01# - 10#) with preprogrammed EDID.

The **User EDID List** shows the memory locations (1# - 8#) which can be used by the user to save custom EDIDs.

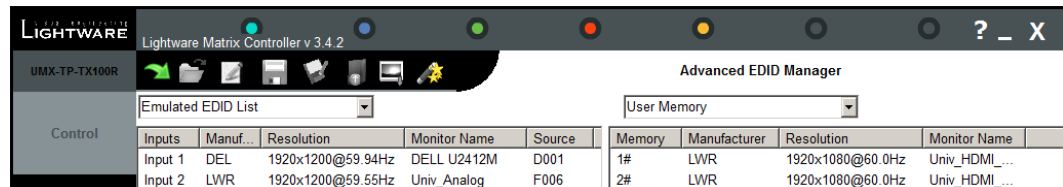

Figure 7-6. EDID Management menu

Any source reads the EDID from the Emulated EDID memory for the corresponding port. The user can select an EDID with the rotary switches to the desired input's memory location. This is called EDID switching. There are two types of the emulation: static and dynamic.

- Static EDID emulation happens, when an EDID from the Factory or User EDID list is selected by the Rotary switches (#1 .. #9). In this case the Emulated EDID will remain the same until the user emulates another EDID.
- Dynamic EDID emulation can be enabled by selecting #0 on the Rotary switch. The attached monitor's EDID is copied to the INPUT, if a new monitor is attached to the output, the emulated EDID changes automatically.

Changing the emulated EDID at one or all inputs

To change the emulated EDID use the Rotary switches on the front panel of the device.

Info: If dynamic emulation is established, the emulated EDID will be changed on the INPUT every time a new monitor is connected to the OUTPUT. If the monitor is disconnected from the output, the last EDID remains emulated for the source. This feature helps especially rental technicians or system integrators to keep the source continuously transmitting the signal, and adopt the system for new incoming display devices.

Info: Power ON/OFF cycle will not affect the emulated EDID or other settings.

Info: EDID routing procedure causes a status change, hence it is reported back to the CONTROL SOFTWARE within 2-3 seconds.

Learning EDID from attached display device

The system is able to learn the EDID from a connected display device and store it in one of the user programmable memory locations.

- Step 1.** Select the User Memory in the drop-down menu in one of the list windows.
- Step 2.** Select the EDID to be saved from the other list window.
- Step 3.** Drag and drop the selected EDID to the desired User Memory location.
- Step 4.** Click Yes in the pop-up dialog window to confirm EDID change.

Saving EDID from memory to file

The control software is able to download EDID from the matrix and to save it as an EDID file (.dat file extension).

- Step 1.** Select the desired EDID list in the drop-down menu in the list windows.

- Step 2.** Right click on the EDID to be saved.
- Step 3.** Click on the “Save to file” in the pop-up window.
- Step 4.** The Matrix Controller Software downloads the desired EDID and a save dialog appears. It may take a few seconds to download the EDID. If the save dialog is shown, type in the file name, and press Save button. After the process was completed, an “EDID saved!” message confirms the command.

Load EDID from file to memory

The system is able to load EDID from a file located on the computer and store it in the matrix. EDID are stored in *.dat files.

- Step 1.** Select the User Memory list in one of the list windows
- Step 2.** Right click on the desired memory location. Then select “Load from file” from the pop-up menu.
- Step 3.** Browse your hard drive to find the desired EDID file. The software checks whether the selected file is a valid EDID file.
- Step 4.** Click Open in the browser window.

Delete EDID

Only user EDIDs can be deleted. Deleting means the factory EDID (Universal HDMI or Analog EDID) will be loaded into the desired user EDID memory.

- Step 1.** Select the User Memory in the drop-down menu in one of the list windows.
- Step 2.** Right click on the desired memory location. Then select “Delete EDID” from the pop-up menu.
- Step 3.** Click Yes in the pop-up dialog window to confirm EDID delete.

7.4.2. Advanced EDID Editor

This powerful tool is essential for AV professionals. The Lightware Advanced EDID Editor is integrated into the Lightware Matrix Controller software, and it makes possible to manage every setting in the EDID on an intuitive user interface. The editor can read and write all descriptors, which are defined in the standards, including the additional CEA extensions.

Any EDID from the router’s memory or a saved EDID file can be loaded in the editor. The software resolves the raw EDID, and displays it as readable information to the user. All descriptors can be edited, and saved in an EDID file, or uploaded to the router’s memory.

By clicking on the green arrow, the editor area rolls down.

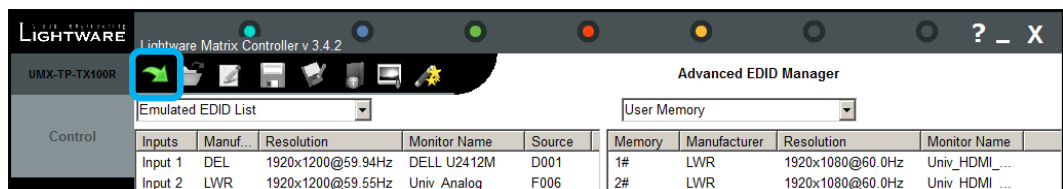

When the user enters the menu for the first time, an empty EDID is loaded into the editor’s memory.

All EDID in the router’s memory can be edited in the following way:

- Step 1.** Right click on the desired EDID to be loaded to the EDID Editor.
- Step 2.** In the pop-up menu, click on Edit EDID. The editor area automatically rolls down, and the EDID is loaded into the editor area.

For further information, see the user's manual of Advanced EDID Editor on the Lightware website: www.lightware.com

7.4.3. Easy EDID Creator

Since the above mentioned advanced editor needs more complex knowledge about EDID, Lightware introduced a wizard like interface for fast and easy EDID creation. With Lightware Easy EDID Creator it is possible to create custom EDIDs in four simple steps.

By clicking on the wizard icon, the Easy EDID Creator opens in a new window.

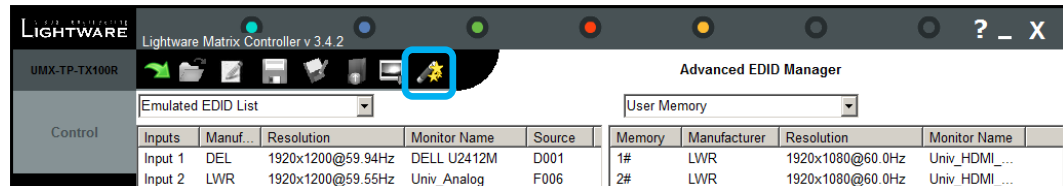

For further information, see the user's manual of Easy EDID Creator on the Lightware website: www.lightware.com

7.5. Terminal menu

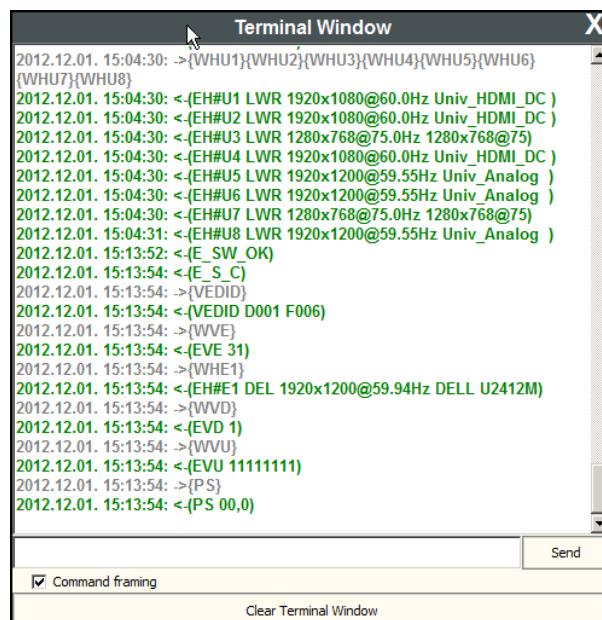

Figure 7-7. Terminal window

This general-purpose serial terminal is intended mainly for testing and debugging purposes. After a successful connection is established with a router this terminal can be used via serial connection. All commands can be used here that are discussed in the **Error! Not a valid bookmark self-reference.**, chapter 8 on page 52. The text can be typed directly.

By default commands are automatically surrounded by framing brackets. Every sent command and every received response gets an arrow (-> or <-) prefix, and has different font colors in order to help distinguishing.

If the "Command framing" checkbox is unchecked, you can send multiple commands together, however in this case you have to type in the framing brackets manually.

7.6. Status menu

Basic device information, such as the installed boards' firmware and hardware revisions are displayed in this window.

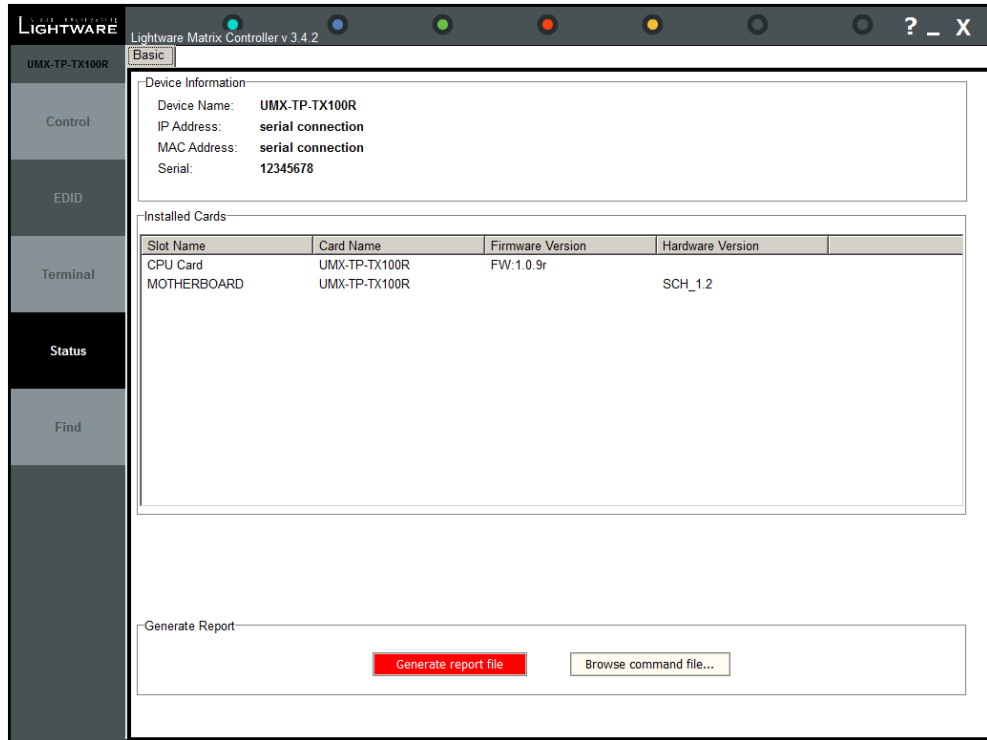

Figure 7-8. Status menu

7.6.1. Generate report file

Lightware Matrix Controller allows user to generate a standard report file which contains basic information about the health and the version numbers of the matrix.

The default file name is:

Lightware_matrix_standard_report_dd_mm_yyyy@hh_mm.lwr

User's issues can be solved easier by Lightware technical support if the generated report file was sent.

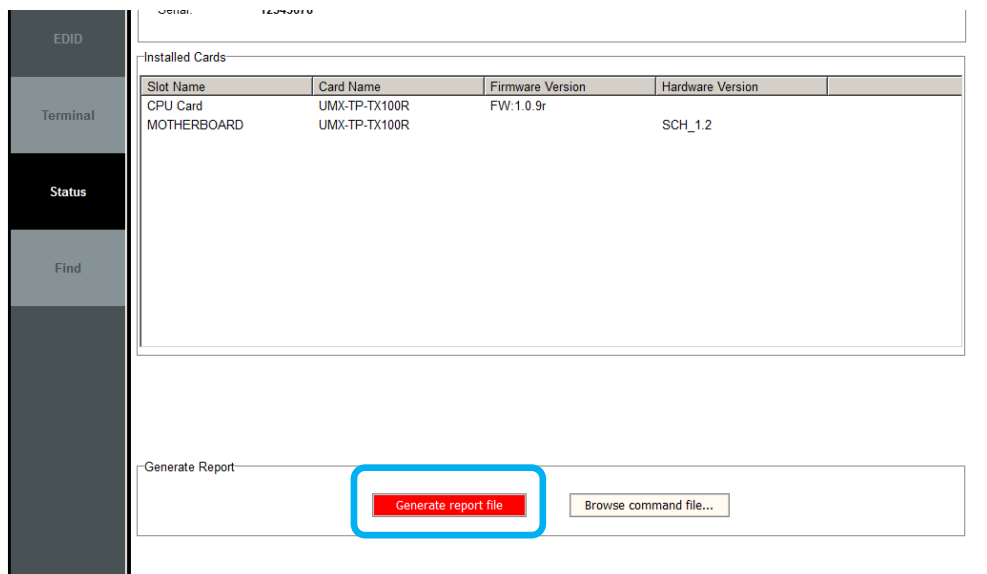

During the process a big red message will be appeared:

Generating standard report...

Important!

Let the Lightware Matrix Controller software to finish the process! Do not exit or select another menu item.

After finishing a window explorer will be opened and shown the actual folder which contains the generated report file.

7.6.2. Browse command file

Lightware Matrix Controller software can run a special command file. After running the software save a result file. It is useful for debugging for the Lightware technical support.

If a command file was sent:

Step 1. Save it to the computer.

Step 2. Click to the 'Browse command file...' button. A browser window will be opened.

Step 3. Choose the command file. Another browser window will be appeared where the generated result file will be saved.

Important!

Let the Lightware Matrix Controller software to finish the process! Do not exit or select another menu item.

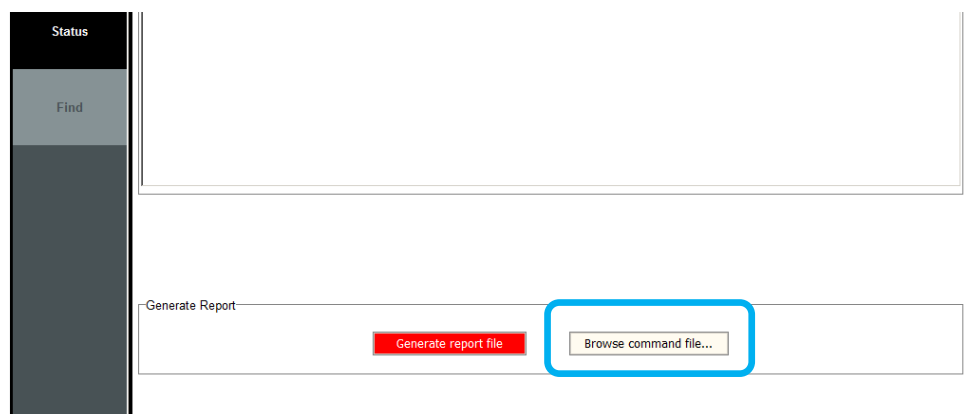

During the process a big red message will be appeared:

Generating standard report...

7.7. Find menu

By clicking this menu, the available devices can be rescanned on the serial port and on the Ethernet. If the Matrix Controller Software has a live connection to a device on a port, a question window appears, asking if you really want to search for devices.

Clicking Yes will open the Find window. See section [7.2](#) about establishing the connection on page [39](#).

Clicking No will close the pop up window, the original connection remains active.

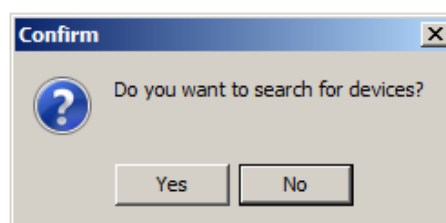

8. Programmers reference

Users can connect to the extender through serial port.

Lightware UMX-TP-TX100R can be controlled with external devices which can communicate according to the extender protocol.

8.1. Serial port settings

UMX-TP-TX100R uses RS-232 communication port. D-SUB connector pin assignments can be found in section [4.6](#) on page [20](#).

The device uses standard RS-232 interface with the following default settings:

57600 Baud, 8 data bit, 1 stop bit, no parity

The serial port baud rate can be changed with protocol command. See section [8.4.2](#) on page [56](#).

8.2. Protocol description

The protocol description hereinafter stands for Lightware protocol.

The devices accept commands surrounded by curly brackets - { } - and responds with data surrounded by round brackets - () - only if a command was successfully executed. All input commands are converted to uppercase, but respond commands can contain upper and lower case letters as well.

Legend for control commands:

| | | |
|---------------------|---|---|
| <in> | = | input number in 1 or 2 digit ASCII format (01,5,07,16 etc.) |
| <out> | = | output number in 1 or 2 digit ASCII format |
| <in ² > | = | input number in 2 digit ASCII format (01, 02, 10, 12 etc.) |
| <out ² > | = | output number in 2 digit ASCII format (01, 02, 10, 12 etc.) |
| <loc> | = | location number in 1, 2 or 3 digit ASCII format |
| <id> | = | id number in 1 or 2 digit ASCII format |
| <id ² > | = | id number in 2 digit ASCII format |
| < <i>italic</i> > | = | italic parameters are optional |
| CrLf | = | Carriage return, Line feed (0x0D, 0x0A) |
| • | = | space character (0x20) |
| → | = | each command issued by the controller |
| ← | = | each response received from the router |

ASCII table:

The most frequently used characters are highlighted.

| Dec | Hex | Char | Dec | Hex | Char | Dec | Hex | Char | Dec | Hex | Char |
|-----|-----|-------|-----|-----|---------|-----|-----|------|-----|-----|-------|
| 0 | 00 | [NUL] | 32 | 20 | [Space] | 64 | 40 | @ | 96 | 60 | ` |
| 1 | 01 | [SOH] | 33 | 21 | ! | 65 | 41 | A | 97 | 61 | a |
| 2 | 02 | [STX] | 34 | 22 | " | 66 | 42 | B | 98 | 62 | b |
| 3 | 03 | [ETX] | 35 | 23 | # | 67 | 43 | C | 99 | 63 | c |
| 4 | 04 | [EOT] | 36 | 24 | \$ | 68 | 44 | D | 100 | 64 | d |
| 5 | 05 | [ENQ] | 37 | 25 | % | 69 | 45 | E | 101 | 65 | e |
| 6 | 06 | [ACK] | 38 | 26 | & | 70 | 46 | F | 102 | 66 | f |
| 7 | 07 | [BEL] | 39 | 27 | ' | 71 | 47 | G | 103 | 67 | g |
| 8 | 08 | [BS] | 40 | 28 | (| 72 | 48 | H | 104 | 68 | h |
| 9 | 09 | [TAB] | 41 | 29 |) | 73 | 49 | I | 105 | 69 | i |
| 10 | 0A | [LF] | 42 | 2A | * | 74 | 4A | J | 106 | 6A | j |
| 11 | 0B | [VT] | 43 | 2B | + | 75 | 4B | K | 107 | 6B | k |
| 12 | 0C | [FF] | 44 | 2C | , | 76 | 4C | L | 108 | 6C | l |
| 13 | 0D | [CR] | 45 | 2D | - | 77 | 4D | M | 109 | 6D | m |
| 14 | 0E | [SOH] | 46 | 2E | . | 78 | 4E | N | 110 | 6E | n |
| 15 | 0F | [SI] | 47 | 2F | / | 79 | 4F | O | 111 | 6F | o |
| 16 | 10 | [DLE] | 48 | 30 | 0 | 80 | 50 | P | 112 | 70 | p |
| 17 | 11 | [DC1] | 49 | 31 | 1 | 81 | 51 | Q | 113 | 71 | q |
| 18 | 12 | [DC2] | 50 | 32 | 2 | 82 | 52 | R | 114 | 72 | r |
| 19 | 13 | [DC3] | 51 | 33 | 3 | 83 | 53 | S | 115 | 73 | s |
| 20 | 14 | [DC4] | 52 | 34 | 4 | 84 | 54 | T | 116 | 74 | t |
| 21 | 15 | [NAK] | 53 | 35 | 5 | 85 | 55 | U | 117 | 75 | u |
| 22 | 16 | [SYN] | 54 | 36 | 6 | 86 | 56 | V | 118 | 76 | v |
| 23 | 17 | [ETB] | 55 | 37 | 7 | 87 | 57 | W | 119 | 77 | w |
| 24 | 18 | [CAN] | 56 | 38 | 8 | 88 | 58 | X | 120 | 78 | x |
| 25 | 19 | [EM] | 57 | 39 | 9 | 89 | 59 | Y | 121 | 79 | y |
| 26 | 1A | [SUB] | 58 | 3A | : | 90 | 5A | Z | 122 | 7A | z |
| 27 | 1B | [ESC] | 59 | 3B | ; | 91 | 5B | [| 123 | 7B | { |
| 28 | 1C | [FS] | 60 | 3C | < | 92 | 5C | \ | 124 | 7C | |
| 29 | 1D | [GS] | 61 | 3D | = | 93 | 5D |] | 125 | 7D | } |
| 30 | 1E | [RS] | 62 | 3E | > | 94 | 5E | ^ | 126 | 7E | ~ |
| 31 | 1F | [US] | 63 | 3F | ? | 95 | 5F | _ | 127 | 7F | [DEL] |

8.3. Status and identification commands

8.3.1. View product type

Description: Identification of the device. Type 'i' or 'I' then the router responds its name.

| Format | Example |
|-------------------------------|-------------------------|
| Command {I} | → {i} |
| Response (<PRODUCT_TYPE>)CrLf | ← (I:UMX-TP-TX100R)CrLf |

Legend: <PRODUCT_TYPE> shows the router model.

Explanation: The connected device is an UMX-TP-TX100R.

8.3.2. View serial number

Description: The extender responds its 8-digit serial number.

| Format | Example |
|--------------------------------|---------------------|
| Command {S} | → {s} |
| Response (<SERIAL_NUMBER>)CrLf | ← (SN:10170142)CrLf |

Legend: < SERIAL_NUMBER > shows the serial number of the extender.

Explanation: The connected device's serial number is 10170142.

Info:

Only the last 4 numbers are written onto the back of the router

8.3.3. View Firmware version of the CPU

Description: View the CPU firmware revision.

| Format | Example |
|-------------------------------|-------------------|
| Command {F} | → {f} |
| Response (FW:<FW_VER><S>)CrLf | ← (FW:1.0.9r)CrLf |

Legend: <FW_VERSION> is the firmware version. It is followed by <s> string which may indicate special versions. <s>=r indicates standard version.

Explanation: The connected device's firmware version is 1.0.9r.

8.3.4. View installed controllers' firmware

Description: Shows the firmware revisions of the installed controllers.

| Format | Example |
|-----------------------|----------------|
| Command {FC} | → {fc} |
| Response (CF●END)CrLf | ← (CF END)CrLf |

Explanation: There is no installed controller. This command is reserved for compatibility reasons.

8.3.5. View device's temperature

Description: Queries temperature status.

| Format | Example |
|--------------------------|--|
| Command {ST} | → {st} |
| Response (ST●<DESC>)CrLf | ← (ST CPU N/A N/A N/A N/A N/A 36.2C)CrLf |

Legend: <DESC> N/A N/A N/A N/A N/A – reserved for compatibility reasons
INNER TEMPERATURE

Explanation: Internal temperature is shown.

8.3.6. View CPU firmware compile time

Description: Shows the CPU firmware compile time.

| Format | Example |
|---|---|
| Command {CT} | → {ct} |
| Response (Compiled:<DATE>•<TIME>• Build:<tag>)CrLf | ← (Compiled:Sep 21 2012 14:06:36 Build:4427)CrLf |

Legend: <DATE> Month, Day and Year
<TIME> Hours, minutes and seconds
<tag> Identification number of the firmware

Explanation: The firmware was made in 21.09.2012, 14:06:36 and the identification number of the firmware is 4427.

8.3.7. View installed I/O boards

Description: Shows the hardware name and revision of the installed cards. The number of responses varies regarding the frame size (number of slots).

| Format | Example |
|--|---|
| Command {IS} | → {is} |
| Response (SL#•0•<MB_DESC>)CrLf (SL•END)CrLf | ← (SL# 0 UMX-TP-TX100R SCH_1.2)CrLf ← (SL END)CrLf |

Legend: Slot 0 represents the motherboard.
<MB_DESC> The motherboard description contains the name and the version number.

Explanation: The extender reports that it has one motherboard called UMX-TP-TX100R and its version number is SCH_1.2.

8.4. System commands

8.4.1. Query current control protocol

Description: Shows the RS-232 control protocol.

| Format | Example |
|--|-------------------------------|
| Command {P_?} | → {p_?} |
| Response (CURRENT•PROTOCOL• =•#<x>)CrLf | ← (CURRENT PROTOCOL = #1)CrLf |

Legend: <x> stands for the active protocol.

Explanation: Protocol 1 is active here.

Info: User can query the protocol only. This command is reserved for compatibility reasons.

8.4.2. Change RS-232 baud rate

Description: The RS-232 baud rate can be set. The command has to be sent with the earlier baud rate but the response comes with the new baud rate.

| Format | Example |
|---------------------------------|------------------------|
| Command {RS232BAUD=<rate>} | → {RS232BAUD=9600} |
| Response (RS232BAUD=<rate>)CrLf | ← (RS232BAUD=9600)CrLf |

Explanation: The device RS-232 port is set to 9600 Baud.

Possible settings:

| <rate> | Baud rate | |
|--------|--------------|-----------|
| 9600 | 9600 Baud | |
| 19200 | 19 200 Baud | |
| 38400 | 38 400 Baud | |
| 57600 | 57 600 Baud | (default) |
| 115200 | 115 200 Baud | |

8.4.3. Query RS-232 baud rate

Description: The RS-232 baud rate can be checked. It works via RS-232 as well, but if it is used the command has to be sent with the appropriate baud rate.

| Format | Example |
|---------------------------------|-------------------------|
| Command {RS232BAUD=?} | → {RS232BAUD=?} |
| Response (RS232BAUD=<rate>)CrLf | ← (RS232BAUD=57600)CrLf |

Legend: Please read section [8.4.2](#) on page [56](#).

Explanation: The device communicates with 57600 Baud on the RS-232 port.

8.4.4. Reload factory defaults

Description: Factory default settings can be reloaded for different functions separately. Multiple functions can be entered.

| Format | Example |
|--------------------------------------|------------------------------------|
| Command {FACTORY=<f1>;<f2>;...;<fx>} | → {factory=xpoint;iocards;edidmem} |
| Response (FACTORY●<f1>...)CrLf | ← (FACTORY XPOINT...)CrLf |
| (FACTORY●<f2>...)CrLf | ← (FACTORY IOCARDS...)CrLf |
| ... | ← (FACTORY EDIDS...)CrLf |
| (FACTORY●<fx>...)CrLf | |

Legend: <f1>, <f2> are the names of the functions which have to be reset to factory default. Any number of <fx> can be entered, separated by semicolons.

| <fx> | Restores factory settings to | Additional response |
|---------|--|--|
| XPOINT | Crosspoint table and configuration | none |
| IONAMES | Input and output names | (INAME#1=Input1) (ONAME#1=Output1) |
| IOCARDS | All I/O settings for boards currently in the frame | none |
| EDIDMEM | Clear User and Dynamic EDIDs | (DE_OK) (E_SW_OK) ... (E_SW_OK) |
| ALL | Restores all of the factory settings listed above | none |

Explanation: Factory default settings reloaded for crosspoint and I/O card configurations and emulated EDIDs.

Info: The response may contain additional messages as the router makes the configurations. These responses can be omitted.

Info: After resetting the needed parameters, the device restarts.

Warning! Reloading factory defaults by protocol command does NOT AFFECTS the serial operation mode and the RS-232 baud rate options as well. Only reload factory defaults by the MEM0+MEM0+LEARN combination affects the RS-232 settings. For more information see section [6.12](#) on page [37](#).

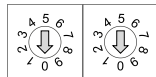

+LEARN = Restore factory defaults

8.4.5. Set the RS-232 operation mode

Description: This command sets the RS-232 port operation mode.

| Format | Example |
|-----------------------------|-----------------------|
| Command {RS232=<mode>} | → {rs232=control} |
| Response (RS232=<mode>)CrLf | ← (RS232=CONTROL)CrLf |

Legend: <mode> Two kinds of operation modes can be:
 <CONTROL> The CPU in the transmitter can receive commands and send responses.
 <PASS> The serial connectors on the transmitter and on the receiver are linked together.

Explanation: The device can be controlled via RS-232 port.

8.4.6. Query the RS-232 operation mode

Description: This command queries the current RS-232 operation mode.

| Format | Example |
|-----------------------------|-----------------------|
| Command {RS232=?} | → {rs232=?} |
| Response (RS232=<mode>)CrLf | ← (RS232=CONTROL)CrLf |

Legend: Please read section [8.4.5](#) on page [57](#).

Explanation: The device can be controlled via RS-232 port.

8.4.7. Count HDCP keys

Description: If there is an HDCP source on the HDMI input of the device, the device can ask the source whether it can handle <num> piece of sink devices.

| Format | Example |
|---------------------------------|--------------------------|
| Command {;HDCPTEST<in>@<num>} | → {;hdcptest1 @8} |
| Response (HDCPTEST=SUCCESS)CrLf | ← (HDCPTEST=SUCCESS)CrLf |

Legend: <in> input port where the key counting will be executed. This input port must be selected.

<num> the number of the HDCP keys

Explanation: The source on the 1st input can handle 8 HDCP sink devices.

8.4.8. Clear HDCP key cache

Description: The device stores the HDCP keys from the connected devices. These cached keys can be cleared with this command.

| Format | Example |
|------------------------|------------------|
| Command { :HDCPRESET } | → { :hdcpreset } |
| Response (Done)CrLf | ← (Done)CrLf |

Explanation: HDCP key cache is cleared.

Info: This function is useful when too many keys were cached and a connected source device cannot accept so many keys.

8.4.9. Restart matrix router

Description: The extender can be restarted without unplugging power.

| Format | Example |
|---------------------------|--------------------------|
| Command { RST } | → { rst } |
| Response (Booting...)CrLf | ← (Booting...)CrLf |
| (<name>•Ready!)CrLf | ← (UMX-TP-TX100R Ready!) |

Legend: <name> is the type of the extender

Explanation: The extender reboots and sends a message when it is ready.

Info: The response can be seen only if the connection to the extender is still alive.

8.4.10. View error list

Description: Shows the basic error list since last boot up.

| Format | Example |
|--|--------------------------------------|
| Command { ELIST=? } | → { elist=? } |
| Response (ELIST#<num>•<elevel>•<code>•<param>•<occ>)CrLf | ← (ELIST#1 Notice BOOT p:6 o:1)CrLf |
| ... | ... |
| (ELIST#<num>•<elevel>•<code>•<param>•<occ>)CrLf | ← (ELIST#2 Notice READY p:0 o:1)CrLf |

Legend:

- <num>: line number
- <elevel>: NOTICE = Not an error. Initialization information.
WARNING = Possible problem without influencing normal operation.
MATTER = Problem that may lead to further errors.
ERROR = Serious error. Must report to support.
FATAL = Fatal error. Normal operation is not possible.
- <code>: short name for type of log entry
- <param>: technical parameter
- <occ>: occurrence number for this type of log entry

Explanation: There are no errors only standard notices that occur on boot up.

Info: The error list can contain NOTICES and WARNINGS under normal operation. These entries do not mean that there is any problem with the matrix!

8.4.11. Configure remote alerts

Description: The device logs different levels of errors. Configure which level of errors has to be sent out as an alarm message.

| | Format | Example |
|----------|--|--------------------------------|
| Command | {ELEVELSEND#<p>=<0>,<1>,<2>,<3>,<4>} | → {ELEVELSEND#1=0,0,1,1,1} |
| Response | (ELEVELSEND#<p>=<0>,<1>,<2>,<3>,<4>)CrLf | ← (ELEVELSEND#1=0,0,1,1,1)CrLf |

Explanation: The device will send an immediate message on all control interfaces when a 'matter', 'error' or 'fatal' level error occurs.

Legend: <p>: Adjusted control interface must be 1 = RS-232

| | |
|-----------------------------|--|
| <0>: 'Notice' level events | 0 = no immediate message send 1 = immediate message |
| <1>: 'Warning' level events | 0 = no immediate message send 1 = immediate message |
| <2>: 'Matter' level events | 0 = no immediate message send 1 = immediate message |
| <3>: 'Error' level events | 0 = no immediate message send 1 = immediate message |
| <4>: 'Fatal' level events | 0 = no immediate message send 1 = immediate message |

See section [8.4.10](#) on page [58](#) for more information about error levels.

8.4.12. Query level of remote alerts

Description: User can check which level of errors has to be sent out as an alarm message.

| | Format | Example |
|----------|--|--------------------------------|
| Command | {ELEVELSEND#<p>=?} | → {ELEVELSEND#1=?} |
| Response | (ELEVELSEND#<p>=<0>,<1>,<2>,<3>,<4>)CrLf | ← (ELEVELSEND#1=0,0,1,1,1)CrLf |

Legend: Please read section [8.4.11](#) on page [59](#).

Explanation: The device will send an immediate message on all control interfaces when a 'matter', 'error' or 'fatal' level error occurs.

8.4.13. Set the priority settings

Description: This command sets the video priority mode.

| | Format | Example |
|----------|-----------------------------|-------------------------|
| Command | {VIDEOPRIORITY=<pmode>} | → {videopriority=1} |
| Response | (VIDEOPRIORITY=<pmode>)CrLf | ← (VIDEOPRIORITY=1)CrLf |

Legend: <pmode> Two kinds of video priority modes can be:

| | |
|-----|---|
| <0> | First detect First the device check the HDMI than the VGA video input port. That port will be selected which contains valid video signal. |
| <1> | HDMI priority If there is a valid signal on the HDMI input, these port always will be selected, even if the active port was the VGA input port. |

Explanation: The device uses HDMI priority in video autoselect mode.

8.4.14. Query the priority settings

Description: This command queries the video priority mode.

| Format | Example |
|--------------------------------------|-------------------------|
| Command {VIDEOPRIORITY=?} | → {videopriority=?} |
| Response (VIDEOPRIORITY=<pmode>)CrLf | ← (VIDEOPRIORITY=1)CrLf |

Legend: Please read section [8.4.13](#) on page [59](#).

Explanation: The device uses HDMI priority in the autoselect mode.

8.5. EDID router commands

The EDID router manipulates the EDID memory, which has memory locations that are assigned to specific input or output ports. Please read section [5](#) on page [21](#) about EDID memory structure.

Warning! Emulated EDIDs can be switched with the rotary switches only.

8.5.1. Save EDID to user memory (Learn EDID)

Description: Learn EDID from <loc2> to <loc1>.

| Format | Example |
|-------------------------|-----------------|
| Command {<loc1>:<loc2>} | → {u3:d1} |
| Response (E_SW_OK)CrLf | ← (E_SW_OK)CrLf |
| (E_S_C) CrLf | ← (E_S_C)CrLf |

Legend: <loc1> has to be 'Uxx'.

<loc2> can be 'Fxx' or 'Uxx' or 'Dxx'.

Explanation: EDID from the output 1 is saved to user EDID #3.

Info: The router sends (E_S_C) only if the new EDID is different from the earlier one.

8.5.2. View emulated EDIDs on all inputs

Description: Shows the currently emulated EDIDs for both input. The value at the given index (<in1>, <in2>) shows which EDID is used on that particular input.

| Format | Example |
|----------------------------------|-------------------------|
| Command {VEDID} | → {vedid} |
| Response (VEDID●<in1>●<in2>)CrLf | ← (VEDID F001 D001)CrLf |

Legend: Both <inx> indexes show a <loc> which was copied to that input port.

Explanation: F001 (Factory preset EDID F01) is emulated on the input 1. EDID from output is dynamically emulated on input 2.

8.5.3. Watch EDID validity table

Description: Shows EDID validity table, which contains information about the EDID memory states.

| Format | Example |
|--|---|
| Command {WV<type>} | → {wv*} |
| Response (EV<type>● <VALIDITY_TABLE>)CrLf | ← (EVU 31111111)CrLf ← (EVD 1)CrLf ← (EVE 11)CrLf |

Legend:

| <type> | <name> | Response length |
|--------|----------------------------|-----------------|
| F | Factory preset EDIDs | 10 |
| U | User saved EDIDs | 8 |
| D | Dynamic EDID | 1 |
| E | Emulated EDIDs | 2 |
| * | All 'U', 'D' and 'E' EDIDs | |

Each number represents the EDID validity state for the corresponding memory location.

| Value | Description |
|-------|--------------|
| '0' | invalid EDID |
| '1' | valid EDID |
| '3' | changed EDID |

Explanation: There is one '3' in the first row on the 1st position. This means that the user EDID is changed since the last EDID query on that port.

Info: If a changed EDID is queried by the {WH} command (see the next section), its value returns to '1'.

Info: EDID deleting means the universal EDID will be upload to the deleted EDID's place.

8.5.4. View EDID header

Description: Shows basic information about EDIDs in the memory.

| Format | Example |
|---|--|
| Command {WH<loc>} | → {whe1} |
| Response (EH#<loc>● <EDID_HEADER>)CrLf | ← (EH#E1 LWR 1920x1080@60Hz Univ_HDMI_DC)CrLf |

Legend: Depending on <loc> the query can be for one EDID, all EDID in the block.

| <loc> | Result | Response |
|-------|--------------------------|------------------------------------|
| Fxx | Factory EDID query | header for one EDID |
| Uxx | User EDID query | |
| Dxx | Dynamic EDID query | |
| Exx | Emulated EDID query | |
| F* | All Factory preset EDIDs | headers for all (10) Factory EDIDs |
| U* | All User saved EDIDs | headers for all (8) user EDIDs |
| D* | All Dynamic EDIDs | header from the output (1) |
| E* | All Emulated EDIDs | headers from both inputs (2) |

<EDID_HEADER> consists of 3 fields separated by spaces:

PNPID code The three letter abbreviation of the manufacturer

Preferred resolution The resolution and refresh rate stored in the preferred detailed timing block.

Name The name of display device stored in product descriptor.

Explanation: Shows the EDID from the input 1.

8.5.5. Download EDID content from the router

Description: EDID hex bytes can be read directly. The router will issue the whole content of the EDID present on memory location <loc> (256 bytes).

| Format | Example |
|---|---|
| Command {WE<loc>} | → {wef1} |
| Response (EB#<loc>●<B1>●<B2>●..●<B256>)CrLf | ← (EB#F1 00 FF FF FF FF FF FF 00 32 F2 00 00 00 00 92) CrLf |

Legend: <B1> .. <B256> are space separated hex characters represented in ASCII format.

Explanation: Full EDID from memory location 1 is downloaded.

8.5.6. Upload EDID content to the router

Description: EDID hex bytes can be written directly to the user programmable memory locations.

Sequence:

- Step 1.** Prepare the router to accept EDID bytes to the specified location <loc> with command {WL#<loc>}
- Step 2.** Router responds that it is ready to accept EDID bytes with (E_L_S)CrLf
- Step 3.** Send 1 block of EDID (1 block consist of 8 bytes of hex data represented in ASCII format) with command:
{WB#<num>●<B1>●<B2>●<B3>●<B4>●<B5>●<B6>●<B7>●<B8>}
- Step 4.** The router acknowledges with response (EL#<num>)
- Step 5.** Repeat steps 3 and 4 to send the remaining 31 blocks of EDID (32 altogether)
- Step 6.** After the last acknowledge, the router indicates that the EDID status changed by sending (E_S_C) CrLf

| Format | Example |
|---|-----------------------------------|
| Command {WL#<loc>} | → {wl#u3} |
| Response (E_L_S)CrLf | ← (E_L_S) CrLf |
| Command {WB#1●<B1>●<B2>●<B3>●<B4>●<B5>●<B6>●<B7> ●<B8>} | → {wb#1 00 FF FF FF FF FF FF 00} |
| Response (EL#<num>)CrLf | ← (EL#1)CrLf |
| Command {WB#2●<B9>●<B10>●<B11>●<B12>●<B13>●<B14>●<B15>●<B16>} | → {wb#2 38 A3 8E 66 01 01 01 01} |
| Response (EL#<num>) CrLf | ← (EL#2)CrLf |
| ⋮ | ⋮ |
| Command {WB#32●<B249>●<B250>●<B251>●<B252>●<B253>●<B254>●<B255>●<B256>} | → {wb#32 36 59 42 0A 20 20 00 96} |
| Response (EL#<num>) CrLf | ← (EL#32)CrLf |
| Response (E_S_C) CrLf | ← (E_S_C)CrLf |

Legend: <num> represents the sequential number of every 8 byte part of EDID. <num> is between 1 and 32. <B1>..<B256> are the bytes of EDID.

Explanation: Full EDID uploaded to memory location U3.

8.5.7. Delete EDID from memory

Description: Clear EDID from memory location <loc>. Only user EDIDs can be deleted. Deleting means the factory EDID (Universal HDMI or Analog EDID) will be loaded into the desired user EDID memory.

| Format | Example |
|------------------------|---------------|
| Command {DE<loc>} | → {deu3} |
| Response (E_SW_OK)CrLf | ← (E_SW_OK) |
| (DE_OK)CrLf | ← (DE_OK)CrLf |
| (E_S_C)CrLf | ← (E_S_C)CrLf |

Legend: Depending on <loc>, one EDID, or all EDIDs in a block can be cleared.

| <loc> | Result |
|-------|---|
| Fxx | Not valid! Factory EDID cannot be deleted. No response. |
| Uxx | Specified User EDID is deleted. |
| Dxx | Specified Dynamic EDID is deleted. It will be empty until a new monitor is connected. |
| Exx | Specified Emulated EDID cleared. By default F49 EDID is copied to it. |
| F* | Not valid! Factory EDID cannot be deleted. No response. |
| U* | All User EDIDs are deleted. |
| D* | All Dynamic EDIDs are deleted. They will be empty until a new monitor is connected. |
| E* | All Emulated EDIDs are cleared. By default F49 EDID is copied to them. |

Explanation: Third user EDID is cleared from memory.

8.6. Control commands

Description: The following commands with <A/V/AV> option can take effect in multiple layers, according to their parameters. Depending on 'A' or 'V' it can change only the Audio, or only the Video layer; or 'AV' changes both.

Info:

*<A/V/AV> option usually can be skipped for legacy purposes.
In this case using router commands the router changes all (Video & Audio) layers, but using status commands it displays information about only the Video layer.
Please use AV option, when available.*

8.6.1. Switch one input to one output

Description: This command switches the output to an input.

| Format | Example |
|--|--------------------|
| Command {<in>@<out>●<A/V/AV>} | → {2@1 av} |
| Response (O<out ² >●I<in ² >●<A/V/AV>)CrLf | ← (O01 I02 AV)CrLf |

Legend: <A/V/AV>: Layer select:
A: Audio layer
V: Video layer
AV: Audio&Video layer

<in> must be 1,2 or 3.

1: HDMI input

2:VGA input

3: automatic source selection

Explanation: The example shows how to connect both Audio and Video from input 2 to output 1.

Info: If the command is used without the <A/V/AV> parameter, both layers are switched.

Info: UMX-TP-TX100R does not support disconnecting command. {0@<out>}

8.6.2. View video connection on the output

Description: This command shows the video connection status of the output.

| Format | Example |
|---|-----------------|
| Command {?<out>} | → {?1} |
| Response (O<out ² >●I<in ² >)CrLf | ← (O01●I01)CrLf |

Legend: Please read section [8.6.1](#) on page [64](#).

<out> must be 1, 01 or 001.

Explanation: The example shows that video output is connected to input 1

Info: This command kept for legacy purposes; to get information about all layers, please use the multilayer command: [8.6.3](#) on page [64](#).

Info: The response shows connections only for the video layer.

8.6.3. View all connections on the output

Description: This command displays the connections on a single or multiple layers.

| Format | Example |
|---|----------------------------------|
| Command {VC●<A/V/AV>} | → {vc●av} |
| Response (ALLV●<in ² >)CrLf (ALLA●<in ² >)CrLf | ← (ALLV●01)CrLf (ALLA●01)CrLf |

Legend: Please read section [8.6.1](#) on page [64](#).

Explanation: The response contains all the connections, if both layers are selected the response is two messages.
The example shows that output 1 Audio & Video are connected to input 1 Audio & Video.

Info: If the command is used without the <A/V/AV> parameter, the response shows only the video layer connections.

Renaming Inputs / Output

Description: Allows storing names for each input / output. Any 16-byte long string is allowed (16 characters). All characters are converted to uppercase!

8.6.4. Rename an input

| Format | Example |
|--|------------------------------|
| Command {INAME#<id>=<input_name>} | → {iname#2=Media Player} |
| Response (INAME#<id>=<input_name>)CrLf | ← (INAME#2=MEDIA PLAYER)CrLf |

Legend: <id> must be 1 or 2.

Explanation: Input 2 was named as "MEDIA PLAYER".

8.6.5. Rename the output

| Format | Example |
|---|-------------------------|
| Command {ONAME#<id>=<output_name>} | → {ONAME#1=Monitor } |
| Response (ONAME#<id>=<output_name>)CrLf | ← (ONAME#1=MONITOR)CrLf |

Legend: <id> must be 1.

Explanation: Output was named as "MONITOR".

Query names of Inputs / Output

Description: Each input / output name can be read from the router.

8.6.6. Read an input's name

| Format | Example |
|---|------------------------------|
| Command {INAME#<in>=?} | → {iname#2=?} |
| Response (INAME#<in>= <input_name>)CrLf | ← (INAME#2=MEDIA PLAYER)CrLf |

Legend: <id> must be 1 or 2.

Explanation: Name for input 2 is "MEDIA PLAYER".

8.6.7. Read the output's name

| Format | Example |
|--|-------------------------|
| Command {ONAME#<out>=?} | → {oname#1=?} |
| Response (ONAME#<out>=<output_name>)CrLf | ← (ONAME#1=MONITOR)CrLf |

Legend: <id> must be 1.

Explanation: Name for the output is "MONITOR".

Set default names of Inputs / Output

Description: Renames all input / output names to the default: Input 1, Input 2 / Output 1 respectively.

8.6.8. Reload default input names

| Format | Example |
|--------------------------------------|-------------------------|
| Command {INAME#<id>=!} | → {iname#1=!} |
| Response (INAME#<id>=Input●<id>)CrLf | ← (INAME#1=Input 1)CrLf |

Legend: <id> must be 1 or 2.

Explanation: The first input name is set to default: "Input 1".

8.6.9. Reload default output name

| Format | Example |
|---------------------------------------|--------------------------|
| Command {ONAME#<id>=!} | → {oname#1=!} |
| Response (ONAME#<id>=Output●<id>)CrLf | ← (ONAME#1=Output 1)CrLf |

Legend: <id> must be 1.

Explanation: The output name is set to default: "Output 1".

8.7. Port status commands

8.7.1. Input port status

Description: Shows the actual status of the input ports.

| Format | Example |
|------------------------------|----------------|
| Command {:ISD} | → {:isd} |
| Response (ISD●<INPUT_D>)CrLf | ← (ISD 00)CrLf |

Explanation: This command is reserved for compatibility reasons.

Legend: <INPUT_D> contains 2 decimal numbers. Each number must be 00.

8.7.2. Output port status

Description: Shows the actual status of the output ports.

| Format | Example |
|-------------------------------|----------------|
| Command {:OSD} | → {:osd} |
| Response (OSD●<OUTPUT_D>)CrLf | ← (OSD 00)CrLf |

Explanation: This command is reserved for compatibility reasons.

Legend: <OUTPUT_D> contains 1 decimal numbers. It must be 0.

8.7.3. All port status

Description: Shows the actual status of all input and output ports.

| Format | Example |
|--|------------------|
| Command {PS} | → {ps} |
| Response (PS●<INPUT_D>,<OUTPUT_D>)CrLf | ← (PS 00, 0)CrLf |

Explanation: This command is reserved for compatibility reasons.

Legend: <INPUT_D> and <OUTPUT_D> is the same as for {:ISD} and {:OSD} commands. The input and output state tables are separated with a comma “,”

8.8. Input properties

The following commands are setting up the properties of the input ports. If only one or a few parameters have to be modified, the protocol enables to mask the other parameters, so they can stay untouched. To mask a parameter use "x" or "X" as its value.

Example: `{:ANALOG#2@SI=x;x;x;210;x;}` Only change the horizontal position on the input port 2.

8.8.1. Set input port properties

Description: This command changes the setup of the input ports.

| | Format | Example |
|----------|---|---|
| Command | <code>{:DVII#<in>@<S/A>I=<VIDEO>;<X1>;<X2>;<HDCP>}</code> | <code>→ {:dvii#1 @si=x;x;x;1}</code> |
| Response | <code>(DVII#<in>@<S/A>I=<VIDEO>;<X>;<X>;<HDCP>;<STATUS>;<SOURCE>;<ATIM1/DCS>;<ATIM2/DRES>;<ARES/HAUDIO>;<HASAMP><HCH>)CrLf</code> | <code>← (DVII#1 @SI=D;x;x;1;3;H;20;1920x1080p60;P;48;)CrLf</code> |

Explanation: This command enables the HDCP encryption.

Legend:

- `<S/A>`: **Affected ports:**
S = single selected input
A = all inputs
- `<VIDEO>`: **Video source: (read-only)**
A = Automatic analog (color space detected by sync)
D = Digital (HDMI / YPbPr)

Info: Video source gives information about the source. It is a read-only parameter. Automatic analog (A) setting available with analog VGA INPUT and Digital (D) setting available with HDMI INPUT.

`<X1>`: Reserved for compatibility reasons. Don't care.
`<X2>`: Reserved for compatibility reasons. Don't care.

Info: The following parameters are available above 1.0.9 firmware version

Info: HDCP setting available only on the HDMI input port.

`<HDCP>`: **HDCP capability:**
0 = disabled,
1 = enabled.

Info: The following parameters cannot be set, they only appear in response.

`<STATUS>` **Status** (hexadecimal):
bit 0: (LSB): Power 5V
0 = not detected
1 = detected
bit 1: Source signal HDCP:
0 = not protected
1 = protected
bit 2: Don't care
bit 3: Don't care

`<SOURCE>` **Actual video source:**
H = HDMI
D = DVI
R = RGBHV (analog signal, separate HV sync)
C = Component signal (analog signal, embedded sync)
- = No video detected.

Source dependent parameters:

Analog signal properties are displayed, when <SOURCE> = R / C:

- <ATIM1> **Analog timing1:**
 - 0 = SMTPE standard
 - 1 = User saved preset
 - 2 = EDID detailed timing
 - 3 = Factory preset
 - 4 = GTF formula
 - 5 = User modified (not saved)
- <ATIM2> **Analog timing2:** (depending on <ATIM1>)
 - <ATIM1> = 0 -> SMTPE record number
 - <ATIM1> = 1 -> User preset number
 - <ATIM1> = 2 -> Detailed timing number
 - <ATIM1> = 3 -> Factory preset number
 - <ATIM1> = 4 -> Fixed zero.
- <ARES> **Resolution string.** (example: 1600x1200p60)

Digital signal properties are displayed, when <SOURCE> = H / D:

- <DCS> 2 byte hexadecimal number:
 - bit 0 = 1: Color depth: 30 bit/pixel (not supported)
 - bit 1 = 1: Color depth: 36 bit/pixel
 - bit 2 = 1: Color depth: 48 bit/pixel (not supported)
 - bit 0&1&2 =0: Color depth: 24 bit/pixel
 - bit 4: Color space: YCbCr422
 - bit 5: Color space: YCbCr444
- <DRES> **Incoming resolution string.** (example: 1600x1200p60)

If HDMI signal present <SOURCE> = H, there are more HDMI specific parameters:

- <HAUDIO> **HDMI Audio properties:**
 - 0 = no audio
 - P = 2 channel stereo (L-PCM)
 - M = Multichannel-PCM (M-PCM)
 - S = Compressed audio
 - H = HBR audio
 - D = DST audio (not supported)
 - E = DSD audio (not supported)
- <HASAMP> If <HAUDIO> not S or H: HDMI audio sample rate in kHz.
 - <HAUDIO> = S (Compressed) multiply by 32,
 - <HAUDIO> = H (HBR) multiply by 4

| | | |
|-----|-------|-----|
| 32 | 32 | kHz |
| 44 | 44,1 | kHz |
| 48 | 48 | kHz |
| 88 | 88,2 | kHz |
| 96 | 96 | kHz |
| 176 | 176,4 | kHz |
| 192 | 192 | kHz |

<HCH> Contains CEA-861 compatible channel assignment, if M-PCM signal present:

| | | | | | | | | |
|------|---|---|----|----|----|-----|----|----|
| 0x00 | - | - | - | - | - | - | FR | FL |
| 0x01 | - | - | - | - | - | LFE | FR | FL |
| 0x02 | - | - | - | - | FC | - | FR | FL |
| 0x03 | - | - | - | - | FC | LFE | FR | FL |
| 0x04 | - | - | - | RC | - | - | FR | FL |
| 0x05 | - | - | - | RC | - | LFE | FR | FL |
| 0x06 | - | - | - | RC | FC | - | FR | FL |
| 0x07 | - | - | - | RC | FC | LFE | FR | FL |
| 0x08 | - | - | RR | RL | - | - | FR | FL |
| 0x09 | - | - | RR | RL | - | LFE | FR | FL |
| 0x0A | - | - | RR | RL | FC | - | FR | FL |

| | | | | | | | | |
|------|-----|-----|----|----|----|-----|----|----|
| 0x0B | - | - | RR | RL | FC | LFE | FR | FL |
| 0x0C | - | RC | RR | RL | - | - | FR | FL |
| 0x0D | - | RC | RR | RL | - | LFE | FR | FL |
| 0x0E | - | RC | RR | RL | FC | - | FR | FL |
| 0x0F | - | RC | RR | RL | FC | LFE | FR | FL |
| 0x10 | RRC | RLC | RR | RL | - | - | FR | FL |
| 0x11 | RRC | RLC | RR | RL | - | LFE | FR | FL |
| 0x12 | RRC | RLC | RR | RL | FC | - | FR | FL |
| 0x13 | RRC | RLC | RR | RL | FC | LFE | FR | FL |
| 0x14 | FRC | FLC | - | - | - | - | FR | FL |
| 0x15 | FRC | FLC | - | - | - | LFE | FR | FL |
| 0x16 | FRC | FLC | - | - | FC | - | FR | FL |
| 0x17 | FRC | FLC | - | - | FC | LFE | FR | FL |
| 0x18 | FRC | FLC | - | RC | - | - | FR | FL |
| 0x19 | FRC | FLC | - | RC | - | LFE | FR | FL |
| 0x1A | FRC | FLC | - | RC | FC | - | FR | FL |
| 0x1B | FRC | FLC | - | RC | FC | LFE | FR | FL |
| 0x1C | FRC | FLC | RR | RL | - | - | FR | FL |
| 0x1D | FRC | FLC | RR | RL | - | LFE | FR | FL |
| 0x1E | FRC | FLC | RR | RL | FC | - | FR | FL |
| 0x1F | FRC | FLC | RR | RL | FC | LFE | FR | FL |

Where:

| | |
|-----|--------------------|
| FL | Front Left |
| FC | Front Center |
| FR | Front Right |
| FLC | Front Left Center |
| FRC | Front Right Center |
| RL | Rear Left |
| RC | Rear Center |
| RR | Rear Right |
| RLC | Rear Left Center |
| RRC | Rear Right Center |
| LFE | Subwoofer |

8.8.2. Query input port properties

Description: Check status of the input ports.

| Format | Example |
|---|--|
| Command { :DVII#<in>@<S/A>I=? } | → { :dvii#1 @si=? } |
| Response (DVII#<in>@<S/A>I= <VIDEO>; <X1>; <X2>; <HDCP>; <STATUS>; <SOURCE>; <ATIM1/DCS>; <ATIM2/DRES>; <ARES/HAUDIO>; <HASAMP>; <HCH>.)CrLf | ← (DVII#1 @SI= D; x; x; 1; 3; H; 20; 1920x1080p60; P; 48;)CrLf |

Legend: Please read section [8.8.1](#) on page [67](#).

Explanation: This command queries the HDMI input port properties.

8.8.3. Set analog timing properties

Description: This command changes the setup of the analog timing data.

| Format | Example |
|--|---|
| Command {: ANALOG# <in>@<S/A>I= <PHS>;<FHS>; <HS>;<VS>; <HP>;<VP>;} Response (D VII# <in>@<S/A>I= <PHS><FHS>; <HS>;<VS>; <HP>;<VP>; <LCF>; <FORM>;<VSP>;<HSP>; <FPS>;)CrLf | → {: analog#2 @si= 10;2160; 1600;1200; 455;41;} ← (ANALOG#2 @SI= 10;2160; 1600;1200; 455;41; 1124; P;-;-; 50;)CrLf |

Legend: <S/A>: **Affected ports:**
 S = single selected input
 A = all inputs
 <PHS> Phase
 <FHS> Full Horizontal Size
 <HS> Horizontal Size
 <VS> Vertical Size
 <HP> Horizontal Position
 <VP> Vertical Position

Info: The following parameters cannot be set, they only appear in response.

 <LCF> Full Vertical Size (Line Count per Field)
 <FORM> Format: Progressive or Interlaced
 <VSP> Vertical Sync. Polarity
 <HSP> Horizontal Sync. Polarity
 <FPS> Frame Per Sec in Hz

8.8.4. Query analog timing properties

Description: Check analog timing data of the input ports.

| Format | Example |
|---|--|
| Command {: ANALOG# <in>@<S/A>I=?} Response (A NALOG# <in>@<S/A>I= <PHS>;<FHS>; <HS>;<VS>; <HP>;<VP>;<LCF>; <FORM>;<VSP>;<HSP>;<FPS>)CrLf | → {: analog#2 @si=?} ← (A NALOG#2 @SI= 0;2160; 1600;1200; 455;41;1242; P;+;+;60;)CrLf |

Legend: Please read section [8.8.3](#) on page [70](#).

8.8.5. Reset analog timing properties

Description: This command resets the analog timing properties.

| Format | Example |
|---|--|
| Command {: ANALOG# <in>@<S/A>I=RESET} Response (A NALOG# <in>@<S/A>I= <PHS>;<FHS>; <HS>;<VS>; <HP>;<VP>;<LCF>; <FORM>;<VSP>;<HSP>;<FPS>)CrLf | → {: analog#2 @si=reset} ← (A NALOG#1 @SI= 0;2160; 1600;1200; 455;41;1242; P;+;+;60;)CrLf |

Legend: Please read section [8.8.3](#) on page [70](#).

8.8.6. Set analog color properties

Description: Set analog color properties data of the input ports.

| | Format | Example |
|----------|---|---|
| Command | {:PICTURE#<in>@<S/A>I= <DF_CHA>;<DF_CHB>;<DF_CHC>; <G_CHA>;<G_CHB>;<G_CHC>; <O_CHA>;<O_CHB>;<O_CHC>; <CONT>;<SAT>;<BRIGHT>;<HUE>;) | → {:picture#2@si= 1023;1023;1023; 1023;1023;1023; 1023;1023;1023; 128;128;0;0;)CrLf |
| Response | (PICTURE#<in>@<S/A>I= <DF_CHA>;<DF_CHB>;<DF_CHC>; <G_CHA>;<G_CHB>;<G_CHC>; <O_CHA>;<O_CHB>;<O_CHC>; <CONT>;<SAT>;<BRIGHT>;<HUE>;)CrLf | ← (PICTURE#2@SI= 1023;1023;1023; 1023;1023;1023; 1023;1023;1023; 128;128;0;0;)CrLf |

Legend:

<S/A>: **Affected ports:**
 S = single selected input
 A = all inputs

<DF_CHA> **Digital fine-clamp for CH-A:**
 0-4096

<DF_CHB> **Digital fine-clamp for CH-B:**
 0-4095

<DF_CHC> **Digital fine-clamp for CH-C:**
 0-4095

<G_CHA> **Gain for CH-A:**
 0-1023

<G_CHB> **Gain for CH-B:**
 0-1023

<G_CHC> **Gain for CH-C:**
 0-1023

<O_CHA> **Offset for CH-A:**
 0-1023

<O_CHB> **Offset for CH-B:**
 0-1023

<O_CHC> **Offset for CH-C:**
 0-1023

<CONT> **Contrast:**
 0-255

<SAT> **Saturation:**
 0-255

<BRIGHT> **Brightness:**
 0-255

<HUE> **Hue:**
 0-127

Info: Analog color setting will not be saved automatically. User can save it with the next command.

8.8.7. Save analog color properties

Description: Save analog color properties of the input ports.

| | Format | Example |
|----------|--|---|
| Command | {:PICTURE#<in>@<S/A>I=SAVE} | → {:picture#3@si=save)CrLf |
| Response | (P SAVED)CrLf (PICTURE#<in>@<S/A>I= <DF_CHA>;<DF_CHB>;<DF_CHC>; <G_CHA>;<G_CHB>;<G_CHC>; <O_CHA>;<O_CHB>;<O_CHC>; <CONT>;<SAT>;<BRIGHT>;<HUE>;)CrLf | ← (P SAVED)CrLf ← (PICTURE#3@SI= 1023;1023;1023; 1023;1023;1023; 1023;1023;1023; 128;128;0;0;)CrLf |

Legend: Please read section [8.8.6](#) on page [71](#).

8.8.8. Query analog color properties

Description: Check analog color properties data of the input ports.

| Format | Example |
|---|---|
| Command {: <i>PICTURE#</i> <in>@<S/A>I=?} | → {: <i>picture#2</i> @si=?} |
| Response (<i>PICTURE#</i> <in>@<S/A>I= <DF_CHA>;<DF_CHB>;<DF_CHC>; <G_CHA>;<G_CHB>;<G_CHC>; <O_CHA>;<O_CHB>;<O_CHC>; <CONT>;<SAT>;<BRIGHT>;<HUE>;)CrLf | ← (<i>PICTURE#2</i> @SI= 1023;1023;1023; 1023;1023;1023; 1023;1023;1023; 128;128;0;0;)CrLf |

Legend: Please read section [8.8.6](#) on page [71](#).

8.8.9. Reset analog color properties

Description: Reset analog color properties of the input ports.

| Format | Example |
|--|--|
| Command {: <i>PICTURE#</i> <in>@<S/A>I=FACTORY} | → {: <i>picture#2</i> @si=factory} |
| Response (P SAVED)CrLf (<i>PICTURE#</i> <in>@<S/A>I= <DF_CHA>;<DF_CHB>;<DF_CHC>; <G_CHA>;<G_CHB>;<G_CHC>; <O_CHA>;<O_CHB>;<O_CHC>; <CONT>;<SAT>;<BRIGHT>;<HUE>;)CrLf | ← (P SAVED)CrLf ← (<i>PICTURE#2</i> @SI= 1023;1023;1023; 1023;1023;1023; 1023;1023;1023; 128;128;0;0;)CrLf |

Legend: Please read section [8.8.6](#) on page [71](#).

8.8.10. Set analog input audio parameters

Description: This command changes the setup of the ADC on the audio board.

| Format | Example |
|---|---|
| Command {: <i>AUDIN#</i> <in>@<S/A>I=<VOL>; <BAL>;<GAIN>;<PHS>;<DCF>} | → {: <i>audin#2</i> @si=0;50;0;0;0;} |
| Response (: <i>AUDIN#</i> <in>@<S/A>I=<VOL>; <BAL>;<GAIN>;<PHS>;<DCF>)CrLf | ← (<i>AUDIN#2</i> @SI=0;50;0;0;0;)CrLf |

Legend:

| | |
|---------|--|
| <S/A>: | Affected ports: S = single selected output A = all outputs |
| <VOL>: | Volume: (default 0) 0, 100, 200, .. , 6200, 6300 where 0 = 0 dB, 6300 = - 63 dB |
| <BAL>: | Balance: (default 50) 0 .. 100 % |
| <GAIN>: | Gain: (default 0) 0, 3, 6, .. , 21, 24 dB |
| <POL>: | Polarity inversion: (default 0) 0 = Normal (phase=0°), 1= Inverted (phase=180°) |
| <DCF>: | Audio DC filter: (default 0) 0 = DC filter off, 1 = DC filter on. |

8.8.11. Query analog input audio properties

Description: This command reads the setup of the ADC on the audio board.

| Format | Example |
|---|--------------------------------|
| Command { :AUDIN#<in>@<S/A>I=? } | → { :audin#2@si=? } |
| Response (:AUDIN#<in>@<S/A>I=<VOL>;<BAL>;<GAIN>;<PHS>;<DCF>)CrLf | ← (AUDIN#2@SI=0;50;0;0;0;)CrLf |

Legend: Please read section [8.8.10](#) on page [72](#).

8.8.12. Set the color of no sync picture

Description: If there is no incoming video signal the device gives a monochrome 640x480p60 picture to the output. This command sets the color of the no sync picture with an RGB value on the active input port.

| Format | Example |
|--|-------------------------------|
| Command { :SETBG#<in>@<S/A>I= <RED>;<GREEN>;<BLUE>; } | → { :setbg#1@si=255;255;0; } |
| Response (SETBG#1@SI= <RED>;<GREEN>;<BLUE>;)CrLf | ← (SETBG#1@SI=255;255;0;)CrLf |

Legend: <S/A>: **Affected ports:**
 S = single selected input
 A = all outputs
 <RED> Red component of RGB value.
 <GREEN> Green component of RGB value.
 <BLUE> Blue component of RGB value.

Explanation: The example shows how to set yellow colored monochrome no sync picture on the HDMI input port.

Info: *Setting of the color of no sync picture is available only on the selected active input.*

8.8.13. Query the color of no sync picture

Description: This command reads the RGB color code of the no sync picture on the active input port.

| Format | Example |
|---|-------------------------------|
| Command { :SETBG#<in>@<S/A>I=? } | → { :SETBG#1@SI=? } |
| Response (SETBG#1@SI= <RED>;<GREEN>;<BLUE>;)CrLf | ← (SETBG#1@SI=255;255;0;)CrLf |

Legend: Please read section [8.8.12](#) on page [73](#).

Explanation: The no sync picture color is the (255, 255, 0) RGB coded yellow on the HDMI input port.

Info: *Querying of the color of no sync picture is available only on the selected active input.*

8.8.17. Delete all presets

Description: This command deletes all the presets from the analog input port.

| Format | Example |
|--------------------------------|-----------------------|
| Command { :AF#<in>@SI=DEL;255} | → { :af#2@si=DEL;255} |
| Response (AF DELETED)CrLf | ← (AF DELETED)CrLf |

Explanation: The command deletes all the presets.

8.8.18. Clone preset

Description: This command clones the desired preset to all of the input ports.

| Format | Example |
|---------------------------------|--------------------|
| Command { :AF#<in>@SI=CL;<PID>} | → { :af#2@si=CL;1} |
| Response (AF CLONED)CrLf | ← (AF CLONED)CrLf |

Legend: <PID> Preset ID number

Explanation: This command is reserved for compatibility reasons.

8.8.19. List presets

Description: This command reads and lists all the saved presets from the analog VGA input port.

| Format | Example |
|--|---|
| Command { :AF#<in>@<S/A>I=LIST} | → { :af#2@si=list} |
| Response (AF#<in>:<PID>= <BL>;<LCF>;<FCL>;<LCVS>; <SCN>;<VSPP>;<HSPP>; <VPL>;<HPP>;<VSL>;<HSP>; <FHSP>;<PHS>;)CrLf (AF END) | ← (AF#2:1= 3045;1249;1864;3; 0;1;1; 50;495;1200;1600; 2161;23;)CrLf ← (AF END) |

Legend:

| | |
|--------|------------------------------------|
| <S/A>: | Affected ports: |
| | S = single selected input |
| | A = all inputs |
| <PID> | Preset ID number |
| <BL>: | (8 x 28.6363M) / fhsync |
| <LCF>: | 28.6363M / (256 * fvsync) |
| <FCL>: | Number of lines in a whole picture |
| <LCVS> | Number of lines during v.sync |
| <SCN> | Screen scan type: |
| | 0 = progressive |
| | 1 = interlaced |
| <VSPP> | V.sync polarity |
| | 0 = negative |
| | 1 = positive |
| <HSPP> | H.sync polarity |
| | 0 = negative |
| | 1 = positive |
| <VPL> | Vertical position in lines |
| <HPP> | Horizontal position in pixels |
| <VSL> | Vertical size in lines |
| <HSP> | Horizontal size in pixels |
| <FHSP> | Full horizontal size in pixels |
| <PHS> | Phase (0 .. 31) |

Explanation: One preset was saved to the input port 2.

8.8.20. Delete preset from all input ports

Description: This command deletes the desired from all analog input ports.

| Format | Example |
|--------------------------------------|-------------------------|
| Command { :AF#<in>@SI=DELALL;<PID> } | → { :af#2@si=delall;1 } |
| Response (AF DELETED)CrLf | ← (AF DELETED)CrLf |

Legend: <PID> Preset ID number

Explanation: This command is reserved for compatibility reasons.

8.9. Output properties

The following commands are setting up the properties of the output ports. If only one or a few parameters have to be modified, the protocol enables to mask the other parameters, so they can stay untouched. To mask a parameter use "x" or "X" as its value.

Example: { :HDMI#1@SO=H;x;x;x;1;} Set output port no. 2 to HDMI 24 bit.

8.9.1. Set output video properties

Description: This command is for configuring output port settings.

| Format | Example |
|--|----------------------------------|
| Command { :HDMI#<out>@<S/A>O= <MODE>; <CSPAC>; <CRANG>; <SUBS>; <HDCP>; } | → { :HDMI#1@SO=H;x;x;x;1; } |
| Response (HDMI#<out>@<S/A>O= G <CON><MODE><SIG> <HDCP><HPD>; O <MODE><CSPAC> <CRANG>;<SUBS> <HDCP>) M <HSUP><AUTH><REP> <YUV4><YUV2> <AUD><PCM><DC>CrLf | ← (HDMI#2@SO=G0H100;OHAAA1;)CrLf |

Legend for command:

<S/A>: **Affected ports:**

S = single-selected output

A = all outputs

<MODE>: **Output signal mode:**

A = Automatic (this setting gives a response as D/H/1/2),

D = DVI,

H = HDMI 24bit,

1 = HDMI 30bit deepcolor,

2 = HDMI 36bit deepcolor.

<CSPAC>: Reserved for legacy reasons. Set 'X' here.

<CRANG>: Reserved for legacy reasons. Set 'X' here.

<SUBS>: Reserved for legacy reasons. Set 'X' here.

<HDCP>: **HDCP encryption:**

A = automatic,

1 = always use.

Legend for response:

G block: General status information

<CON>: **Connection sense:**

0 = There is no attached sink device,

1 = Sink device attached (termination is present)

- <MODE>: **Output signal mode**
D = DVI,
H = HDMI 24bit,
1 = HDMI 30bit deepcolor
2 = HDMI 36bit deepcolor
- <SIG>: **Signal present**
0 = No valid signal is routed to this port,
1 = Valid video signal is present.
- <HDCP>: **HDCP encryption status**
0 = HDCP encryption is inactive,
1 = HDCP encryption is active.
- <HPD>: **Hotplug detection**
0 = Hotplug detect signal is low,
1 = Hotplug detect signal is high.

O block: Actual output settings

- <MODE>: Same as in G block.
<CSPAC>: Reserved for legacy reasons. Response is always 'A'.
<CRANG>: Reserved for legacy reasons. Response is always 'A'.
<SUBS>: Reserved for legacy reasons. Response is always 'A'.
<HDCP>: Same as in G block.

M block: Attached device (monitor) information

- <HSUP>: 0 = Sink device does not support HDMI
1 = Sink device supports HDMI
- <AUTH>: 0 = HDCP authentication failed
1 = HDCP authentication is successful
- <REP>: 0 = Attached device is not an HDCP repeater
1 = Attached device is an HDCP repeater
- <YUV4>: 0 = Attached device does not support YUV 4:4:4
1 = Attached device supports YUV 4:4:4
- <YUV2>: 0 = Attached device does not support YUV 4:2:2
1 = Attached device supports YUV 4:2:2
- <AUD>: 0 = Attached device has no audio capabilities
1 = Attached device has audio capabilities
- <PCM>: This field represents a byte in hexadecimal format.
The binary bits show support for different audio bit rates.
bit 0 - Sink device supports 32kHz PCM audio
bit 1 - Sink device supports 44kHz PCM audio
bit 2 - Sink device supports 48kHz PCM audio
bit 3 - Sink device supports 88kHz PCM audio
bit 4 - Sink device supports 96kHz PCM audio
bit 5 - Sink device supports 176kHz PCM audio
bit 6 - Sink device supports 192kHz PCM audio
bit 7 - Reserved (Always 0 in this version of protocol)
- <DC>: This field is a number in decimal format.
The binary bits show support for different color modes.
bit 2 - HDMI deep color 30bits/pixel mode is supported
bit 1 - HDMI deep color 36bits/pixel mode is supported
bit 0 - YUV444 color space is supported in DC modes

Info: The M block can be missing if there is no attached device on output.

8.9.2. Query output video properties

Description: Displays the status for output port.

| | Format | Example |
|----------|---|---|
| Command | {:HDMI#<out>@<S/A>O=?} | → {:hdmi#1@so=?} |
| Response | (HDMI#<out>@<S/A>O= G<CON><MODE><SIG> <HDCP><HPD>; O<MODE><CSPAC> <CRANG>;<SUBS> <HDCP> M<HSUP><AUTH><REP> <YUV4><YUV2> <AUD><PCM><DC>CrLf | ← (HDMI#1@SO= G1H111; OAAAAA; M100111070;)CrLf |

Legend: Please read section [8.9.1](#) on page [76](#).

8.10. Error responses

Invalid input number

Description: Given input number exceeds the maximum number of inputs or equals zero.

Response (ERR01)CrLf

Invalid output number

Description: Given output number exceeds the installed number of outputs or equals zero.

Response (ERR02)CrLf

Invalid value

Description: Given value exceeds the maximum allowed value can be sent.

Response (ERR03)CrLf

Invalid preset number

Description: Given preset number exceeds the maximum allowed preset number.

Response (ERR04)CrLf

9. Commands – Quick summary

| Router Status commands | Section | Command |
|--|-----------------------|---------|
| View product type | 8.3.1 | {I} |
| View serial number | 8.3.2 | {S} |
| View Firmware version of the CPU | 8.3.3 | {F} |
| View installed controllers' firmware | 8.3.4 | {FC} |
| View device's temperature | 8.3.5 | {ST} |
| View CPU firmware compile time | 8.3.6 | {CT} |
| View installed I/O boards | 8.3.7 | {IS} |

| System commands | Section | Command |
|---|------------------------|--------------------------------------|
| Query current control protocol | 8.4.1 | {P_?} |
| Change RS-232 baud rate | 8.4.2 | {RS232BAUD=<rate>} |
| Query RS-232 baud rate | 8.4.3 | {RS232BAUD=?} |
| Reload factory defaults | 8.4.4 | {FACTORY=<f1>;<f2>;...;<fx>} |
| Set the RS-232 operation mode | 8.4.5 | {RS232=<mode>} |
| Query the RS-232 operation mode | 8.4.6 | {RS232=?} |
| Count HDCP keys | 8.4.7 | {:HDCPTEST<in>@<num>} |
| Clear HDCP key cache | 8.4.8 | {:HDCPRESET} |
| Restart matrix router | 8.4.9 | {RST} |
| View error list | 8.4.10 | {ELIST=?} |
| Configure remote alerts | 8.4.11 | {ELEVELSEND#<p>=<0>;<1>;<2>;<3>;<4>} |
| Query level of remote alerts | 8.4.12 | {ELEVELSEND#<p>=?} |
| Set the priority settings | 8.4.13 | {VIDEOPRIORITY=<pmode>} |
| Query the priority settings | 8.4.14 | {VIDEOPRIORITY=?} |

| EDID router commands | Section | Command |
|---|-----------------------|-----------------|
| Save EDID to user memory (Learn EDID) | 8.5.1 | {<loc1>:<loc2>} |
| View emulated EDIDs on all inputs | 8.5.2 | {VEDID} |
| Watch EDID validity table | 8.5.3 | {WV<type>} |
| View EDID header | 8.5.4 | {WH<loc>} |
| Download EDID content from the router | 8.5.5 | {WE<loc>} |
| Upload EDID content to the router | 8.5.6 | {WL#<loc>} |
| Delete EDID from memory | 8.5.7 | {DE<loc>} |

| Input settings | Section | Command |
|--|------------------------|--|
| Set input port properties | 8.8.1 | {:DVII#<in>@<S/A>I=<VIDEO>;<X1>;<X2>;<HDCP>} |
| Query input port properties | 8.8.2 | {:DVII#<in>@<S/A>I=?} |
| Set analog timing properties | 8.8.3 | {:ANALOG#<in>@<S/A>I=<PHS>;<FHS>;<HS>;<VS>;<HP>;<VP>;} |
| Query analog timing properties | 8.8.4 | {:ANALOG#<in>@<S/A>I=?} |
| Reset analog timing properties | 8.8.5 | {:ANALOG#<in>@<S/A>I=RESET} |
| Set analog color properties | 8.8.6 | {:PICTURE#<in>@<S/A>I=<DF_CHA>;<DF_CHB>;<DF_CHC>;<G_CHA>;<G_CHB>;<G_CHC>;<O_CHA>;<O_CHB>;<O_CHC>;<CONT>;<SAT>;<BRIGHT>;<HUE>;} |
| Save analog color properties | 8.8.7 | {:PICTURE#<in>@<S/A>I=SAVE} |
| Query analog color properties | 8.8.8 | {:PICTURE#<in>@<S/A>I=?} |
| Reset analog color properties | 8.8.9 | {:PICTURE#<in>@<S/A>I=FACTORY} |
| Set analog input audio parameters | 8.8.10 | {:AUDIN#<in>@<S/A>I=<VOL>;<BAL>;<GAIN>;<PHS>;<DCF>} |
| Query analog input audio properties | 8.8.11 | {:AUDIN#<in>@<S/A>I=?} |
| Set the color of no sync picture | 8.8.12 | {:SETBG#<in>@<S/A>I=<RED>;<GREEN>;<BLUE>;} |
| Query the color of no sync picture | 8.8.13 | {:SETBG#<in>@<S/A>I=?} |
| Query timings of the incoming signal | 8.8.14 | {GETTIMINGS#<in>@<S/A>=?} |
| Save preset | 8.8.15 | {:AF#<in>@SI=<IPS>} |
| Delete preset | 8.8.16 | {:AF#<in>@SI=DEL;<PID>} |
| Delete all presets | 8.8.17 | {:AF#<in>@SI=DEL;255} |
| Clone preset | 8.8.18 | {:AF#<in>@SI=CL;<PID>} |
| List presets | 8.8.19 | {:AF#<in>@<S/A>I=LIST} |
| Delete preset from all input ports | 8.8.20 | {:AF#<in>@SI=DELALL;<PID>} |

| Output settings | Section | Command |
|---|-----------------------|--|
| Set output video properties | 8.9.1 | {:HDMI#<out>@<S/A>O=<MODE>;<CSPAC>;<CRANG>;<SUBS>;<HDCP>;} |
| Query output video properties | 8.9.2 | {:HDMI#<out>@<S/A>O=?} |

| Control commands | Section | Command |
|---|-----------------------|----------------------------|
| Switch one input to one output | 8.6.1 | {<in>@<out>•<A/V/AV>} |
| View video connection on the output | 8.6.2 | {?<out>} |
| View all connections on the output | 8.6.3 | {VC•<A/V/AV>} |
| Rename an input | 8.6.4 | {INAME#<id>=<input_name>} |
| Rename the output | 8.6.5 | {ONAME#<id>=<output_name>} |
| Read an input's name | 8.6.6 | {INAME#<in>=?} |
| Read the output's name | 8.6.7 | {ONAME#<out>=?} |
| Reload default input names | 8.6.8 | {INAME#<id>=!} |
| Reload default output name | 8.6.9 | {ONAME#<id>=!} |

| Port status commands | Section | Command |
|------------------------------------|-----------------------|---------|
| Input port status | 8.7.1 | {:ISD} |
| Output port status | 8.7.2 | {:OSD} |
| All port status | 8.7.3 | {PS} |

10. Firmware upgrade

This chapter is meant to help customers perform firmware upgrades on our products by giving a few tips on how to start and by explaining the features of the Bootloader software.

Warning: All EDIDs in the User Memory will be lost after the firmware upgrade. Save the user EDIDs before processing the upgrade.

10.1. Short instructions

- Step 1.** Installing the Lightware Bootloader Software
- Step 2.** Connect the Lightware device and the computer via RS-232 port.
- Step 3.** Start the Lightware Bootloader application
- Step 4.** Find the device
- Step 5.** Connect to the device
- Step 6.** Select firmwares to upgrade
- Step 7.** Starting the upgrade process
- Step 8.** Restart the device

10.2. Detailed instructions

Installing the Bootloader

UMX-TP-TX100R can be upgraded using Lightware Bootloader from a Windows based PC or Laptop via RS-232 port.

10.2.1. Installing and launching the Bootloader software

- Step 1.** Run `Installer_LW_bootloader_v3_2_8.exe` (3_2_8 means the 3-digit firmware version of the Bootloader)

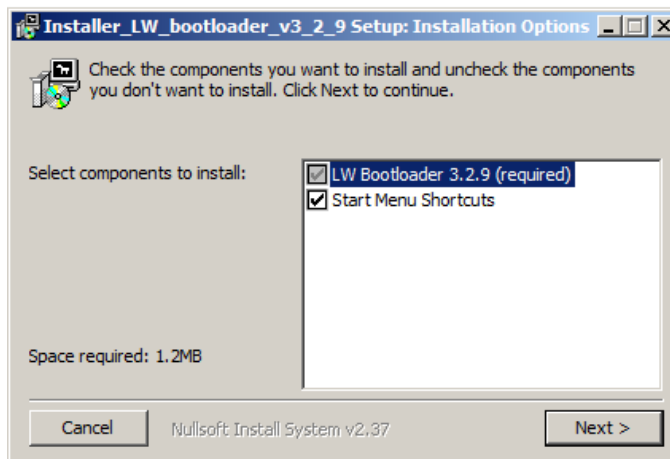

- Step 2.** Select destination folder and select Install (Using the default path is highly recommended)

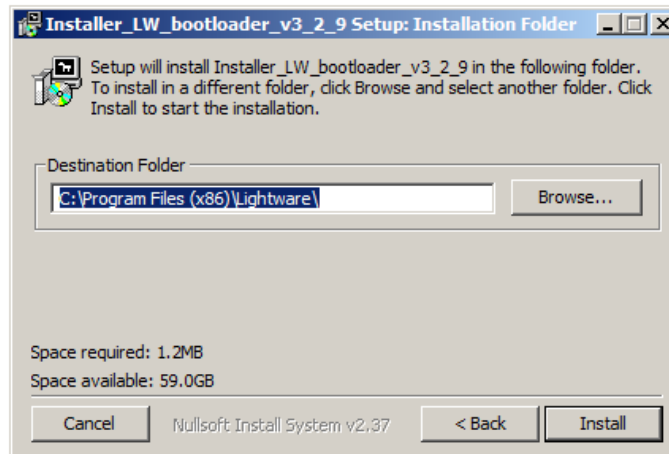

Step 3. If you want to create desktop icon select Yes in the next pop-up window:

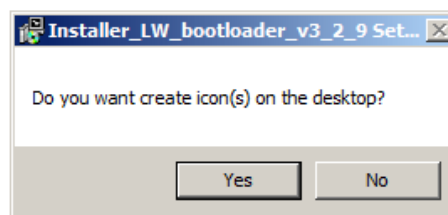

Step 4. After the files have been copied, the following message appears:

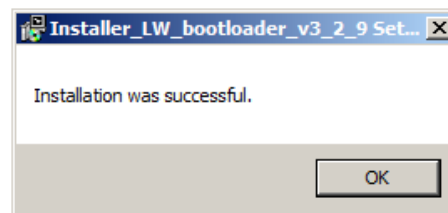

Step 5. To finish the installation process, click on the Close button.

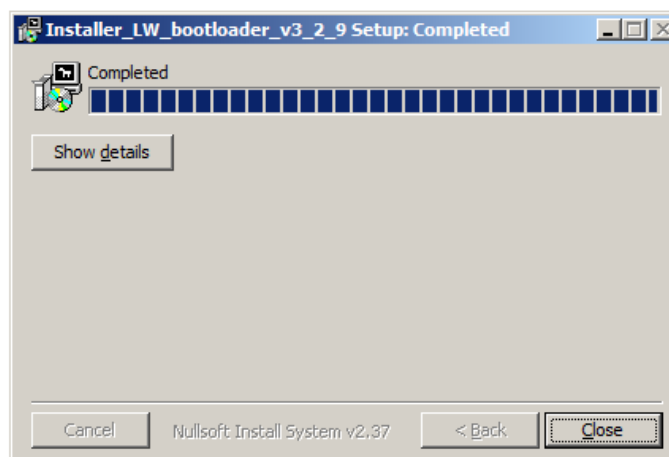

Step 6. To run Lightware Bootloader, find the shortcut icon in Start menu → Programs → Lightware → LW_bootloader_v3_2_8 or on the desktop, and double click on it:

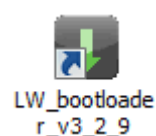

Uninstalling

To uninstall the Bootloader software, double click on: Start menu → Programs → Lightware → Uninstall_LW_bootloader_v3_2_8.exe

10.2.2. Tips for the upgrade process

Remove I/O connections

It is recommended to remove all video input and output connections from the Lightware device. Video sources and display devices may try to communicate with the Lightware device or send noise through the cable which may interfere with the upgrade process.

Latest Bootloader

Always perform the firmware upgrade with the latest Bootloader software. To get the latest Bootloader software, contact your local sales representatives or Lightware's support team at support@lightware.com

Restart the device

After a successful firmware upgrade, the device will restart itself but it is recommended to power down and up the device after finishing the upgrade.

10.2.3. Firmware upgrade

Step 1. Connect the Lightware device and the computer via RS-232 port.

Step 2. Start the application

To run the Bootloader software, double click on the icon of the software on the desktop or select proper shortcut from Start Menu → Programs → Lightware folder.

Step 3. Find devices

Info:

COM ports do not list any information about the connected devices, users must know which COM port is connected to the Lightware device.

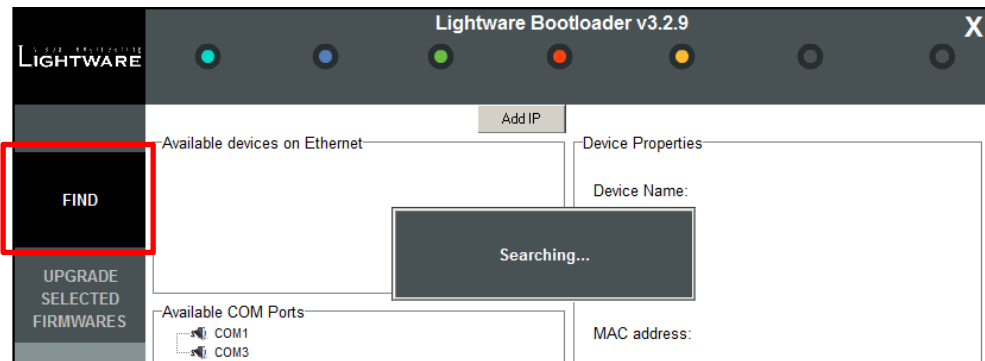
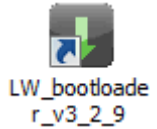

Figure 10-1. Searching for devices

Step 4. Connect to a device

If the Bootloader finds one or more Lightware devices then they will be listed in the tree view window. This window shows the device type, IP address and serial number of the found Lightware devices. COM ports do not query these information, users must know which COM port is connected to the Lightware device. Double click on one of the available devices. The Bootloader will ask if you really want to connect to the device. Select **YES** to establish the connection. It will take 10-15 seconds to get all the information from the Lightware device. After establishing the connection the device enters bootload mode and suspends normal operation.

Warning:

The bootloader application will hold the router in reset state when it establishes the connection. All connected DVI sources and monitors will act as if the router was powered down.

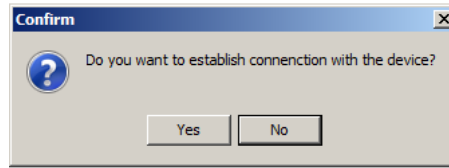

Figure 10-2. Establishing connection

Step 5. Requesting device information

After clicking on the YES button, the device name, serial number and current firmware versions are displayed.

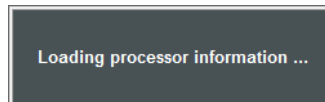

Figure 10-3. Connecting to the device

| | Controller Type | Hardware Version | Bootloader Version | Firmware Version | Browse New Firmware |
|--------------------------|-----------------|------------------|--------------------|------------------|---------------------|
| <input type="checkbox"/> | UMX-TP-TX100R | n/a | n/a | 1.0.8r | |

Figure 10-4. Details of the device

Step 6. Browse new firmware to upgrade

To browse a new firmware file, click the corresponding cell in the “Browse New Firmware” column. Click on **YES** in the pop-up window to modify the path to the new firmware file. Now you can browse for the new firmware file to upload. After opening the new file, the new firmware field will contain the name of the firmware file.

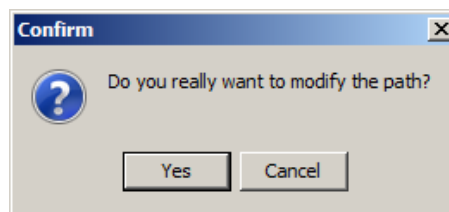

Figure 10-5. Selecting new firmware files

Step 7. Enable the upgrade and Quick Bootload mode

After selecting the new firmware file, you must enable the upgrade by clicking the checkbox left to the controller type (marked with a red circle in the picture below). You may enable Quick Bootload mode by clicking the checkbox next to it (marked with a red rectangle in the picture below). Quick Bootload mode speeds up the process by not reading back the written data, only verifying the checksum. It can be enabled and disabled any time during the upgrade process.

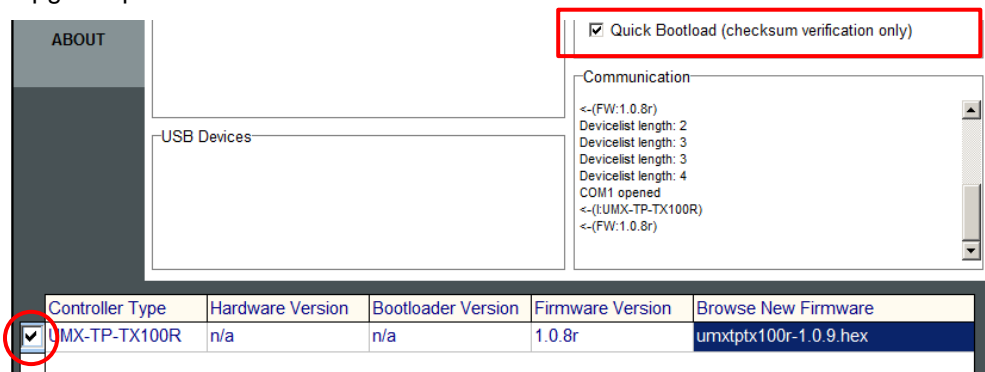

Figure 10-6. Enabling the upgrade and Quick Bootload mode

Step 8. Starting the upgrade process

After selecting all the firmwares that need to be upgraded, click on the **UPGRADE SELECTED FIRMWARES** button. Then click on **YES** in the appearing window to start the process.

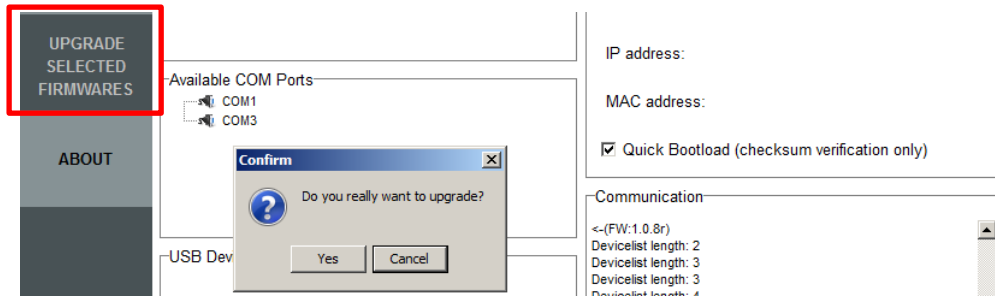

Figure 10-7. Starting the upgrade process

Step 9. Upgrading

The Bootloader will first erase the content of the controllers and then write the new firmware data. This process can be monitored in the communication window and the progress bar (both are marked with red rectangles in the picture below).

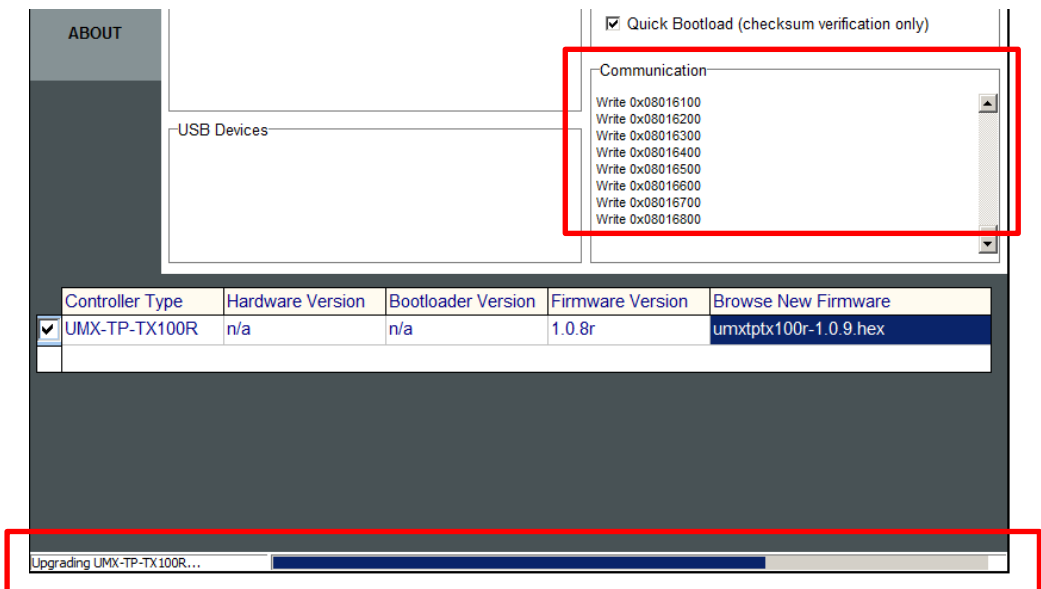

Figure 10-8. Upgrading

Step 10. Closing connections

After all controllers are upgraded, the Bootloader will close the connection with the Lightware device, which will reboot itself and return to its normal operating mode.

Warning:

Bootloader versions that are older than v3.1.8 will not close the connection and restore the Lightware device until you exit the Bootloader.

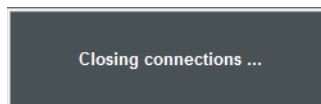

Figure 10-9. Closing connections

Step 11. Upgrade successful

If the connections are closed and no errors occurred, the firmware upgrade is **SUCCESSFUL**. Click on the **OK** button and then you may exit the Bootloader or connect to another Lightware device to perform firmware upgrades.

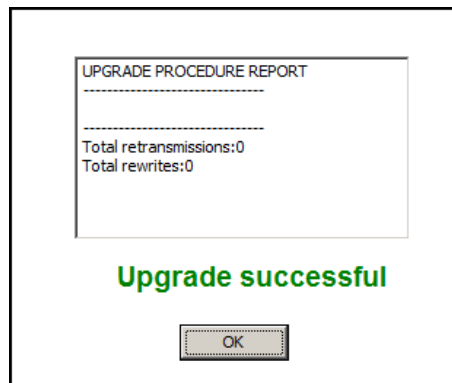

Figure 10-10. Upgrade successful

Step 12. Restart the device

Now you can close the application, or you can select another device to upgrade. After closing the bootloader application, switch the upgraded devices off and then on. Now the extender is ready to be used with the new firmware.

10.3. Forced firmware upgrade

If a previous upgrade process has failed or the extender is not listed in the available device list then the normal firmware upgrading process may not work. In this case the below procedures can help.

Info:

Use this option with caution as the manually given device type is not checked if it is an appropriate Lightware device or not. If the com port belongs to an unknown serial device then this may cause malfunction of the device.

Step 1. Connect the Lightware device and the computer via RS-232 port.

Step 2. Push and hold the LEARN button.

Step 3. While LEARN is holding continuously push and release the RESET button.

Step 4. After releasing the RESET button release the LEARN button.

Step 5. Start the Lightware Bootload application.

Step 6. Right click on the desired COM port and select 'Handle as UMX-TP-TX100R'.

Step 7. The software tries to connect to the device handling it as the selected type. If the connection is successful then the further process is the same as the normal firmware upgrade.

11. Troubleshooting

General problems

Check the device

Check whether the device is properly powered. Try performing a reset through the controller software, or unplug and reconnect the device's power cable.

Important!

Check whether the RESET button is released properly! If the plastic cap gets stuck under the back of the enclosure the device cannot work.

Serial connection problems

Check the cable and software settings

Check whether your male to female straight serial cable is properly connected. In most cases there are more COM ports present in the operating system. Please verify the connection settings of your software. The router communicates by default with **57600** Baud, **8** data bit, **No** parity, **1** stop bit.

Picture is not displayed or distorted

Check the cables (HDMI, VGA)

Due to the high data rates, the cables must fit very well. If your source or display has more connectors then make sure that the proper input port is selected.

Check the cables (TP)

Due to the high data rates, high quality cables must be used. It is recommended to use Cat6 or Cat7 S/FTP cables.

Check the crosspoint state

Check the connection between the input and output port.

Check EDID related problems

Maybe your display device is not capable of receiving the sent video format. Try emulating your display device's EDID to the source.

Check the source

Check whether your source is powered on and configured properly. The HDMI output can be turned off on most DVD players. If the source is a computer, then verify that the VGA output is selected and active. Try restarting your computer; if you get a picture during the booting process, you have to review the driver settings.

HDCP issues

Non HDCP compliant display

Many video sources send HDCP protected signal if they detect that the sink is HDCP capable – even if the content is not copyrighted. This can cause trouble if a HDCP capable device (for example DVI matrix) is connected between the source and the display. In this case the content can't be viewed on non-HDCP capable displays.

Disable HDCP function. For further information please see section [6.9](#) on page [36](#).

12. Specifications

General

| | |
|-----------------------------|----------------------------------|
| Compliance | CE |
| EMI/EMC | EN 55035:2017, EN 55032:2015 |
| Safety | EN 60065:2014, Class II |
| Warranty | 3 years |
| Cooling | Convention only |
| Operating temperature | -20°C ~ +50°C (-4°F to +122°F) |
| Operating humidity | 10 ~ 90% RH, noncondensing |

Power

| | |
|--------------------------|--------------------------------------|
| Power adaptor | External |
| Input | 100-240 V AC 50/60 Hz |
| Output | +12V DC 2.5 A |
| Power consumption* | 3.2 W (typ.) / 4 W (max.) |
| Heat dissipation | 11 BTU/h (typ.) / 13.7 BTU/h (max.) |
| Power need** | depends on the remote powered device |

* Excluding remote power.

** Total power need from the electric outlet, when receiver unit is connected and remote powered by UMX-TP-TX100R. Please note that the power supplied for the external devices is not consumed by the transmitter itself but it is needed from the electric outlet.

Enclosure

| | |
|--------------------------|------------------------|
| Rack mountable | Yes |
| Material | 1 mm steel |
| Dimensions in mm | 221 W x 67.6 D x 21 H* |
| Dimensions in inch | 8.7 W x 2.7 D x 0.9 H* |
| Net Weight | 470 g |

* Excluding connectors.

Control

| | |
|--|--|
| Panel buttons | Yes, 3 buttons and 2 rotary switches |
| Serial port connector | DE-9F (9 pole D-SUB female for RS-232) |
| Available baud rates for control | 9600, 19200, 38400, 57600, 115200 Baud |
| Default baud rate for control | 57600 Baud, 8 bit, 1stop bit, no parity |

Inputs and outputs

| | |
|--------------------------------------|-----------------------------------|
| HDMI input | 19-pole HDMI Type A receptacle |
| Reclocking | Pixel Accurate Reclocking |
| VGA (YPbPr or RGB) input | DE-15F (15-pole D-sub Female) |
| EDID emulation on video inputs | Yes, analog and digital |
| | |
| S/PDIF Digital audio input | RCA receptacle |
| Analog audio input | RCA (for left and right channel) |
| Analog audio signal type..... | analog stereo, unbalanced |
| | |
| VIDEO output | CAT6 RJ45 receptacle |
| DDC output | CAT6 RJ45 receptacle |
| EDID read from output | Yes, analog and digital |
| Pre-emphasis | Yes, fixed 6 dB |
| Serial port | DE-9F (9-pole D-sub Female) |
| Power connector..... | locking DC connector (2.1/5.5 mm) |

Digital video signal

| | |
|------------------------------|--|
| Signal standard | HDMI standard which supports: |
| | Deep color, |
| | Embedded audio |
| | Dolby TrueHD bitstream capable, |
| Color depth | maximum 36 bits, 12 bit/color |
| Color format | RGB, YCbCr 4:4:4, xvYCC digital video |
| Color space conversion | Yes, always from any to RGB |
| Maximum data rates | 6.75 Gbps (2.25 Gbps /TMDS channel) |
| Maximum pixel clock | 225 MHz |
| Video delay | 0 frame |
| Resolutions | all between 640x480 and 2048x1080@60 Hz deep color |
| HDTV resolutions | 720p, 1080i, 1080p |
| Reclocking | Pixel Accurate Reclocking |
| EDID Support | Advanced EDID management (analog and digital) |
| EDID Emulation | Yes, 10 factory preset, 8 user programmable |
| Output mode | Automatic or manual (DVI or HDMI) |
| HDCP compliant | Yes |

RGB input signal

| | |
|----------------------------------|--|
| RGB amplitude | 0.7 V _{p-p} |
| Impedance | 75 Ω |
| G.Sync | 1.0 V _{p-p} |
| Impedance | 75 Ω |
| H.Sync, V.Sync | TTL high impedance, automatic pos/neg polarity |
| Scanning frequency, H.Sync | 15 ~ 100 kHz |
| Scanning frequency, V.Sync | 50 ~ 100 Hz |

YPbPr input signal

| | |
|---|--|
| Y (luminance) amplitude, including sync | 1.0 V _{p-p} |
| Impedance | 75 Ω |
| PbPr/CbCr (chroma) amplitude | 0.7 V _{p-p} |
| Impedance | 75 Ω |
| H.Sync, V.Sync | TTL high impedance, automatic pos/neg polarity |
| Scanning frequency, H.Sync | 15 ~ 100 kHz |
| Scanning frequency, V.Sync | 50 ~ 100 Hz |

General analog audio signal

| | |
|---------------------------|--|
| Overall system gain | -1.3 dB |
| Frequency response | 20 Hz – 0.45 fs (e.g. 21.6 kHz @ 48 kHz) |
| S/N | > 66 dB |

Analog audio input

| | |
|-----------------------------|----------------------------------|
| Impedance | >10 kOhm |
| Coupling mode | AC (capacitive) coupled |
| Nominal level | 0 dBu |
| Maximum level | 1VRMS (~2dBu) |
| Input gain adjustment | + 0 dB ... + 24 dB in 3 dB steps |
| A/D resolution | 24 bits |
| A/D sample rate | 48 kHz, 96 kHz |

Analog audio output

| | |
|---------------------------------------|-------------------------|
| Impedance | 100 Ohms |
| Coupling mode | AC (capacitive) coupled |
| Maximum unloaded level | 1V RMS (~2dbu) |
| Maximum loaded level (@600 Ohm) | 0.86 VRMS (~1dbm) |
| D/A resolution | 24 bits |
| D/A sample rate | 48 kHz, 96 kHz |

Maximum twisted pair distances

| Resolution | Vfreq (Hz) | Pixel clk freq. (MHz) | Cat5e UTP | Cat5e FTP | Cat6 UTP | Cat6 FTP | Cat6 S/FTP | Cat7 S/FTP |
|---------------------|------------|-----------------------|-----------|-----------|----------|----------|------------|------------|
| 640 x 480 | 60 | 25,2 | 60 m | 60 m | 65 m | 70 m | 70 m | 80 m |
| 800 x 600 | 60 | 40,0 | 60 m | 60 m | 65 m | 65 m | 65 m | 75 m |
| 1024 x 768 | 60 | 65,0 | 55 m | 55 m | 60 m | 60 m | 60 m | 75 m |
| 1280 x 720p | 60 | 74,2 | 55 m | 55 m | 60 m | 60 m | 60 m | 70 m |
| 1280 x 1024 | 60 | 108,0 | 50 m | 50 m | 55 m | 60 m | 60 m | 65 m |
| 1400 x 1050 | 60 | 121,8 | 45 m | 45 m | 45 m | 55 m | 55 m | 60 m |
| 1600 x 1200 | 60 | 162,0 | 30 m | 35 m | 35 m | 45 m | 45 m | 50 m |
| 1920 x 1080p | 60 | 148,5 | 30 m | 35 m | 35 m | 45 m | 45 m | 50 m |
| 1920 x 1200p | 60 | 153,0 | 30 m | 35 m | 35 m | 45 m | 45 m | 50 m |

Info: The actual achievable distances may differ, depending on the topology of the whole system. The use of shielded Category 6 cables or Category 7 cables is always recommended.

EDID list

| HDMI Input | | VGA Input | |
|------------|---------------------------------------|-----------|--------------------------------------|
| #0 | Copy from TP OUT (Dynamic EDID) | #0 | Copy from TP OUT (Dynamic EDID) |
| #1 | FACTORY EDID Universal HDMI (default) | #1 | FACTORY EDID Universal VGA (default) |
| #2 | FACTORY EDID 1024x768@60 | #2 | FACTORY EDID 1024x768@60 |
| #3 | FACTORY EDID 1280x720p@60 | #3 | FACTORY EDID 1280x720@60 |
| #4 | FACTORY EDID 1920x1080p@60 | #4 | FACTORY EDID 1920x1080@60 |
| #5 | FACTORY EDID 1920x1200@60 | #5 | FACTORY EDID 1920x1200@60 |
| #6 | USER EDID 1 (def.: Univ. HDMI EDID) | #6 | USER EDID 1 (def.: Univ. VGA EDID) |
| #7 | USER EDID 2 (def.: Univ. HDMI EDID) | #7 | USER EDID 2 (def.: Univ. VGA EDID) |
| #8 | USER EDID 3 (def.: Univ. HDMI EDID) | #8 | USER EDID 3 (def.: Univ. VGA EDID) |
| #9 | USER EDID 4 (def.: Univ. HDMI EDID) | #9 | USER EDID 4 (def.: Univ. VGA EDID) |

13. Mechanical Drawings

The given values are in mm.

Front view

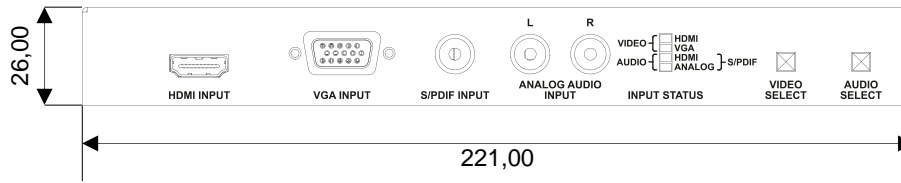

Rear view

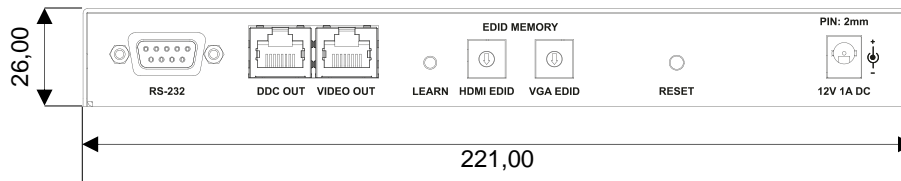

Top view

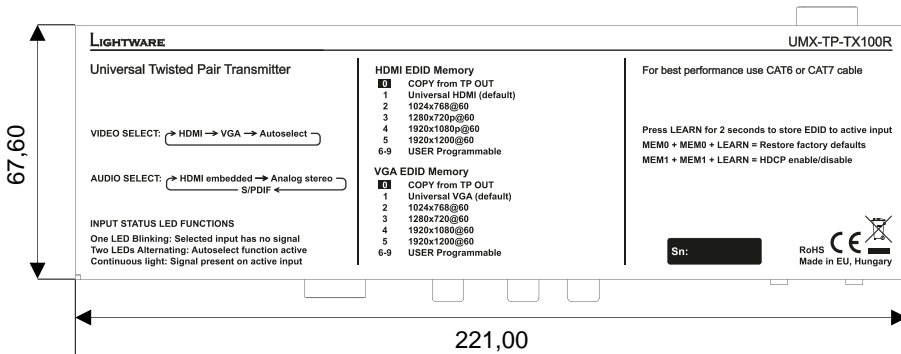

Bottom view

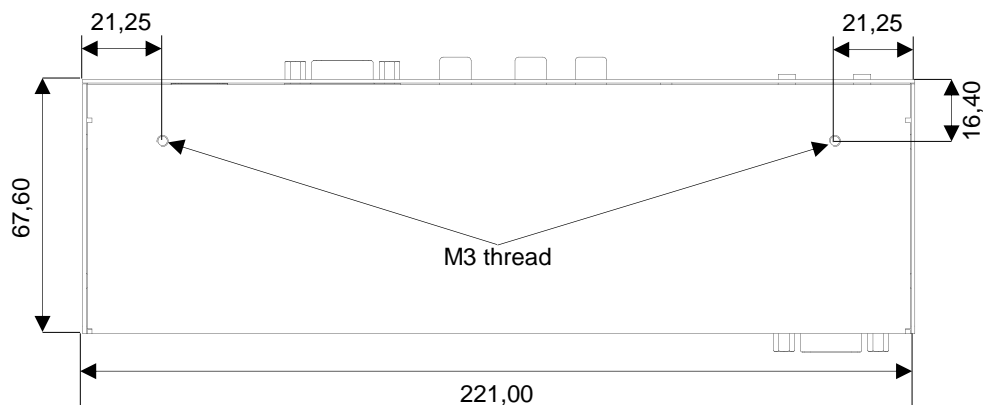

Left view

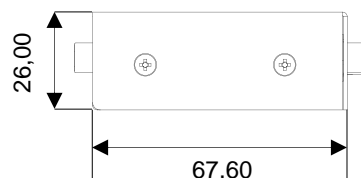

14. Version applicability

This User's Manual applies to the following versions of the mentioned software, firmware and hardware:

| | version |
|--------------------------------------|-------------|
| Lightware Matrix Controller software | 3.4.2 |
| Lightware Bootloader software | 3.2.9 |
| firmware | 1.1.1 |
| hardware | PCB 1.2 |
| enclosure | 224-101-120 |

15. Warranty

Lightware Visual Engineering warrants this product against defects in materials and workmanship for a period of three years from the date of purchase.

The customer shall pay shipping charges when unit is returned for repair. Lightware will cover shipping charges for return shipments to customers.

In case of defect please call your local representative, or Lightware at

Lightware Visual Engineering

15 Peterdy Street, Budapest H-1071, HUNGARY

E-mail: support@lightware.com

16. Document revision history

| Document | Release Date | Changes | Checked by |
|----------|--------------|---|-----------------|
| Rev. 1.0 | 06-05-2013 | Initial version | Zsolt Markó |
| Rev. 1.1 | 16-12-2015 | Safety instructions updated, CE page pulled out | Laszlo Zsedenyi |
| Rev 1.2 | 14-03-2018 | Minor upgrades | Laszlo Zsedenyi |