

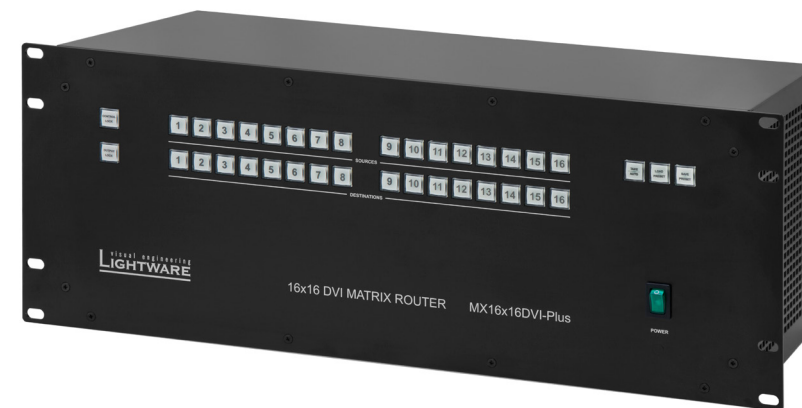

User's Manual



MX9x9DVI-Plus
MX12x12DVI-Plus
MX16x16DVI-Plus

Multimedia Matrix Switcher

Important Safety Instructions

Class I apparatus construction.

This equipment must be used with a mains power system with a protective earth connection. The third (earth) pin is a safety feature, do not bypass or disable it. The equipment should be operated only from the power source indicated on the product.

To disconnect the equipment safely from power, remove the power cord from the rear of the equipment, or from the power source. The MAINS plug is used as the disconnect device, the disconnect device shall remain readily operable.

There are no user-serviceable parts inside of the unit. Removal of the cover will expose dangerous voltages. To avoid personal injury, do not remove the cover. Do not operate the unit without the cover installed.

The appliance must be safely connected to multimedia systems. Follow instructions described in this manual.

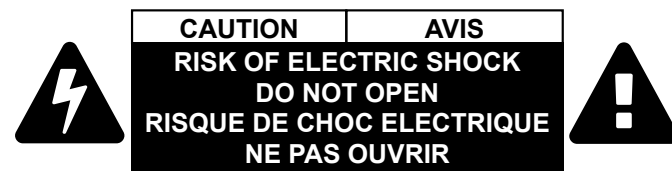

Replacing the AC fuse

Unplug the AC power cord from the device. Locate the AC fuse on the rear panel. Replace only the AC fuse as indicated on the rear panel. Connect the power cord to the switcher and to the AC power source. Make sure the switcher is working properly.

Ventilation

For the correct ventilation and to avoid overheating ensure enough free space around the appliance. Do not cover the appliance, let the ventilation holes free and never block or bypass the ventilators (if any).

WARNING

To prevent injury, the apparatus is recommended to securely attach to the floor/wall or mount in accordance with the installation instructions. The apparatus shall not be exposed to dripping or splashing and that no objects filled with liquids, such as vases, shall be placed on the apparatus. No naked flame sources, such as lighted candles, should be placed on the apparatus.

Waste Electrical & Electronic Equipment WEEE

This marking shown on the product or its literature, indicates that it should not be disposed with other household wastes at the end of its working life. To prevent possible harm to the environment or human health from uncontrolled waste disposal, please separate this from other types of wastes and recycle it responsibly to promote the sustainable reuse of material resources. Household users should contact either the retailer where they purchased this product, or their local government office, for details of where and how they can take this item for environmentally safe recycling. Business users should contact their supplier and check the terms and conditions of the purchase contract. This product should not be mixed with other commercial wastes for disposal.

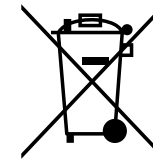

Common Safety Symbols

Symbol	Description
	Alternating current
	Protective conductor terminal
	Equipotential Connector
	On (Power)
	Off (Power)
	Caution, possibility of electric shock
	Caution

Symbol Legend

The following symbols and markings are used in the document:

WARNING! Safety-related information which is highly recommended to read and keep in every case!

ATTENTION! Useful information to perform a successful procedure; it is recommended to read.

INFO: A notice which may contain additional information. Procedure can be successful without reading it.

DEFINITION: The short description of a feature or a function.

TIPS AND TRICKS: Ideas which you may have not known yet but can be useful.

Navigation Buttons

 Go back to the previous page. If you clicked on a link previously, you can go back to the source page by clicking the button.

 Navigate to the Table of Contents.

 Step back one page.

 Step forward to the next page.

Document Information

All presented functions refer to the indicated products. The descriptions have been made during testing these functions in accordance with the indicated Hardware/Firmware/Software environment:

Item	Version
Lightware Device Controller (LDC) software	1.20.0b5
Lightware Bootloader Software	3.3.3
Controller firmware	2.5.0
Hardware	v2.5

Document revision: **3.0**

Release date: 02-03-2018

Editor: Laszlo Zsedenyi

Table of Contents

1. INTRODUCTION	6	5.4.1. Generating a Standard Report	21	7.2.8. Locking an Output	39
1.1. DESCRIPTION	6	5.4.2. Generating a Custom Report	21	7.2.9. Unlocking an Output	39
1.2. BOX CONTENTS	6	5.5. CONFIGURATION MENU	22	7.2.10. Saving a Preset	39
1.3. FEATURES OF THE DEVICE	6	5.5.1. Automatic IP Address Configuration	22	7.2.11. Loading a Preset	39
1.4. TYPICAL APPLICATION	7	5.5.2. Static IP Address Configuration	22	7.2.12. Preset Preview	40
2. INSTALLATION	8	5.5.3. Loading the Default IP Settings	22	7.3. PORT/PRESET NAMING	40
2.1. MOUNTING OPTIONS	8	5.5.4. TCP Port Configuration	23	7.3.1. Querying a Preset Name	40
2.2. CONNECTING STEPS	8	5.5.5. Loading the Default TCP Port Settings	23	7.3.2. Renaming a Preset	40
3. PRODUCT OVERVIEW	9	5.6. TERMINAL MENU	23	7.3.3. Querying an Input Name	40
3.1. FRONT VIEW	9	6. SOFTWARE CONTROL – LIGHTWARE DEVICE CONTROLLER		7.3.4. Renaming an Input	40
3.2. REAR VIEW	10	SOFTWARE	24	7.3.5. Querying an Output Name	40
3.3. ELECTRICAL CONNECTIONS	10	6.1. INSTALL AND UPGRADE	24	7.3.6. Renaming an Output	40
4. OPERATION	12	6.2. RUNNING THE LDC	24	7.3.7. Default Preset Names	40
4.1. POWERING ON	12	6.3. CONNECTING TO A DEVICE (DEVICE DISCOVERY WINDOW)	25	7.3.8. Default Input Names	40
4.2. BASIC CONTROL PANEL OPERATIONS	12	6.4. THE CROSSPOINT MENU	26	7.3.9. Default Output Names	41
4.2.1. CONTROL LOCK	12	6.4.1. Grid View	26	7.4. COMMUNICATION SETUP COMMANDS	41
4.2.2. Take / Autotake Modes	12	6.5. TILE VIEW	28	7.4.1. Querying the IP Settings	41
4.2.3. Viewing the Crosspoint State	12	6.5.1. Port Tiles	29	7.4.2. Reloading the Default IP Settings	41
4.2.4. Switching	13	6.5.2. Display Modes	29	7.4.3. Setting a Dynamic IP Address	41
4.2.5. Switching Operations Flowchart	14	6.5.3. Crosspoint Operations	29	7.4.4. Network Components	41
4.2.6. Preset Operations	14	6.5.4. Presets	30	7.5. PORT STATUS COMMANDS	42
4.2.7. Output Lock	15	6.6. EDID MENU	31	7.5.1. Input Port Status	42
4.3. THE EDID MEMORY OF A MATRIX	16	6.6.1. EDID Operations	32	7.5.2. Output Port Status	42
4.3.1. EDID Types	16	6.6.2. EDID Summary Window	32	7.6. ROUTER STATUS COMMANDS	42
4.4. REMOTE OPERATION	16	6.6.3. Editing an EDID	33	7.6.1. Querying the Product Type	42
4.4.1. Control Interfaces	16	6.6.4. Creating an EDID	33	7.6.2. Querying the Serial Number	42
4.4.2. Multiple Simultaneous Connections	17	6.7. SETTINGS MENU	34	7.6.3. Querying the CPU FW version	42
4.4.3. IP Settings	17	6.7.1. Configuration Tab	34	7.6.4. Querying the CPU FW Compile Time	42
4.4.4. Serial Port Settings	17	6.7.2. Device Information Tab	35	7.6.5. Installed I/O Boards	43
4.4.5. Control Protocols	17	6.7.3. Log Tab	35	7.6.6. Querying the Controllers' Firmware	43
5. SOFTWARE CONTROL - THE BUILT-IN WEB	18	6.7.4. User Preferences	36	7.6.7. Querying the Current Protocol	43
5.1. ESTABLISHING THE CONNECTION	18	6.8. TERMINAL WINDOW	36	7.6.8. Setting the Current Protocol	43
5.2. CONTROL MENU	19	7. PROGRAMMERS' REFERENCE	37	7.6.9. Viewing the Error List	43
5.2.1. Crosspoint Switching	19	7.1. PROTOCOL DESCRIPTION	37	7.6.10. Clearing the Error List	43
5.2.2. Muting the Outputs	19	7.2. SWITCHING AND CONTROL COMMANDS	38	7.7. EDID ROUTER COMMANDS	44
5.2.3. Locking the Outputs	19	7.2.1. Switching an Input to an Output	38	7.7.1. Static EDID Emulation	44
5.2.4. Preset Operations	19	7.2.2. Switching an Input to All Outputs	38	7.7.2. Dynamic EDID Emulation	44
5.3. EDID MENU	20	7.2.3. Querying the I/O Connections	38	7.7.3. Routing an EDID to All Inputs	44
5.3.1. Changing the Emulated EDID at One or All Inputs	20	7.2.4. Resetting the Outputs	39	7.7.4. Querying the Emulated EDIDs	44
5.4. STATUS MENU	21	7.2.5. Querying the Mute States	39	7.7.5. Saving an EDID (Learning)	44
		7.2.6. Muting an Output	39	7.7.6. Viewing the EDID Header	44
		7.2.7. Unmuting an Output	39	7.7.7. Querying the EDID Validity Table	45
				7.7.8. Downloading the Content of an EDID	45

7.7.9. Uploading the Content of an EDID	45
7.7.10. Deleting All EDID from Memory	46
7.8. ROUTER INITIATED COMMANDS	46
7.8.1. Restarting the CPU	46
7.8.2. Restarting the EDID Controller	46
7.8.3. EDID Status Changed	46
7.8.4. Error Responses	46
7.9. COMMANDS – QUICK SUMMARY	47
8. FIRMWARE UPGRADE	49
8.1. SHORT INSTRUCTIONS	49
8.2. DETAILED INSTRUCTIONS	49
8.3. IF THE UPGRADE IS UNSUCCESSFUL	51
9. TECHNOLOGIES	52
9.1. EDID MANAGEMENT	52
9.1.1. Understanding the EDID	52
9.1.2. Advanced EDID Management	52
10. APPENDIX	53
10.1. SPECIFICATIONS	53
10.2. FACTORY EDID LIST	54
10.3. VENTILATION	54
10.4. MECHANICAL DRAWINGS	55
10.5. FURTHER INFORMATION	56

1

Introduction

Thank You for choosing Lightware's MX_DVI-Plus series Frames. In the first chapter we would like to introduce the device highlighting the most important features in the below listed sections:

- ▶ DESCRIPTION
- ▶ BOX CONTENTS
- ▶ FEATURES OF THE DEVICE
- ▶ TYPICAL APPLICATION

1.1. Description

Thank You for choosing Lightware matrix routers. The standalone DVI-Plus matrix routers handle single link DVI signal through various DVI inputs and DVI outputs respectively, which routes any input(s) to any combination of output(s).

The matrix routers comply with DVI and HDMI specification without HDCP encryption, and switch signals between 25 - 225 MHz pixel clock frequency: from 640x480@60Hz to 1920x1200@60Hz or 2048x1080@60Hz resolutions.

The input signals are compensated for 12dB loss and outputs are pre-emphasized by +6dB, this way cable lengths up to 20 meters (65 feet) can be used.

The switcher has an RS-232 and an RJ45 LAN port for remote control applications and a control panel for local control operation. Front panel buttons are illuminated and reconfigurable with text for informative system integration.

Model Denomination

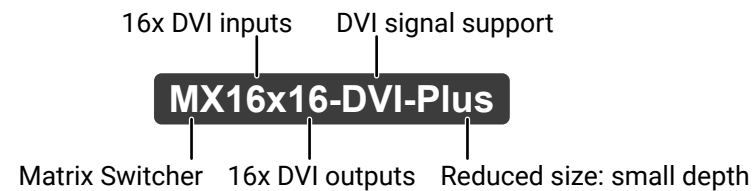

1.2. Box Contents

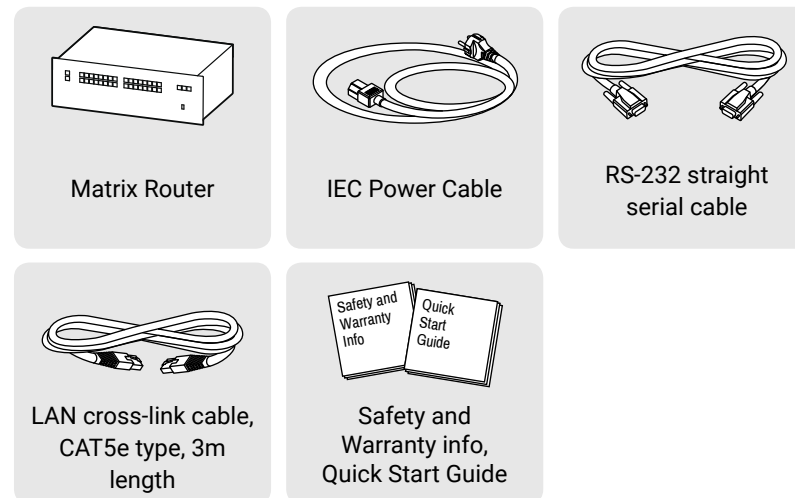

1.3. Features of the Device



Non-blocking Crosspoint Matrix Architecture

The router allows any input to be switched to any output or more outputs simultaneously.



Advanced EDID Management

The user can emulate any EDID on the inputs independently, read out and store any attached monitor's EDID in the internal memory locations.



Supports All HDTV Resolutions and HDCP

720p, 1080i and 1080p etc. signals are supported without HDCP encryption.



Built-in Cable Compensation

Long DVI cables can be connected to the DVI input and output ports thanks to the design of the circuits.



RS-232 Control

Simple ASCII-based protocol can be used for switching, preset calling, status request, etc.



Ethernet Control

Multiple simultaneous TCP/IP connections are available with simple ASCII-based protocol for controlling and configuring the matrix router.



Built-in Website

Easy access from a web browser to control and configure the matrix in systems where software is not allowed to install.



Power Failure Memory

The matrix router starts with its latest configuration settings when powered on or after a power failure. Every setting is stored in a non-volatile memory.



DVI +5V Power Support

500 mA constant current output on each DVI output to power long distance fiber optical cables or other DVI powered devices.



No Signal Latency With Zero Frame Delay

The signal management architecture ensures that there is no delay added between the input and the output.

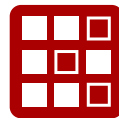

Lightware Device Controller (LDC)

The latest edition of LDC got more intuitive, user friendly, smarter and a modern user interface to control the Lightware devices. The application is available for both Windows and Mac OS X operating systems.

1.4. Typical Application

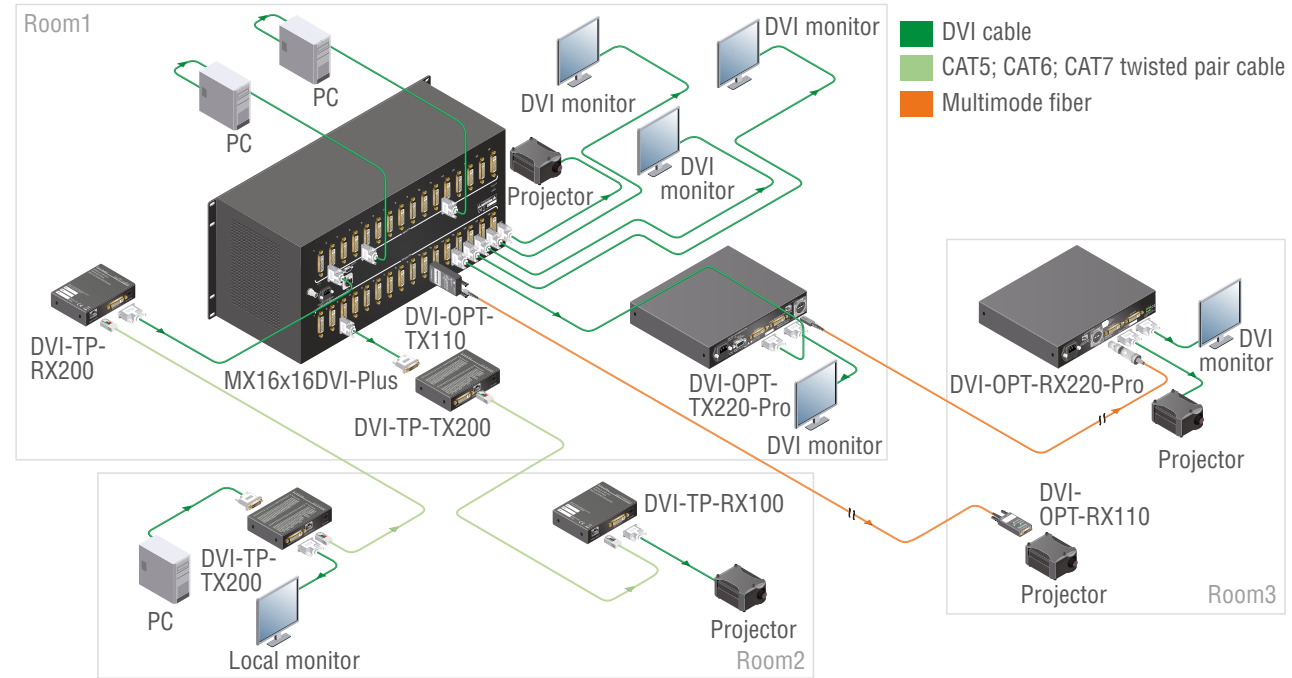

2

Installation

The chapter is about the installation of the device and connecting to other appliances, presenting also the mounting options.

- ▶ MOUNTING OPTIONS
- ▶ CONNECTING STEPS

2.1. Mounting Options

WARNING! For the correct ventilation and to avoid overheating ensure enough free space around the appliance. Do not cover the appliance, let the ventilation holes free and never block or bypass the fans.

The front rack ears allow to mount the device as a standard rack unit installation. Use such type (and size) of screw that fits to the rack rails.

The dimensions of the frames can be found in the [Mechanical Drawings](#) section.

TIPS AND TRICKS: Pay attention to the rear side of the matrix! Let enough free space to (un)plug the cables!

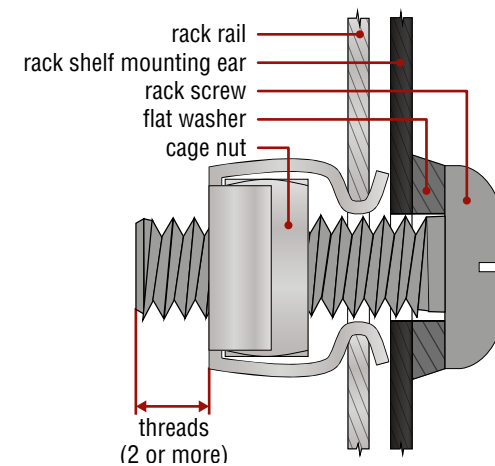
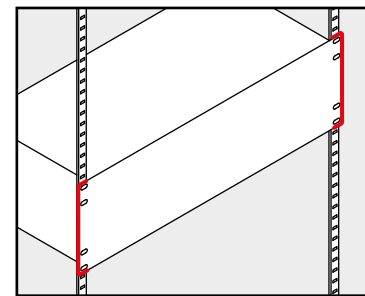

ATTENTION! Fix the frame to the rack rail by applying all mounting holes. Choose properly sized screws for mounting. Keep minimum two threads left after the nut screw.

2.2. Connecting Steps

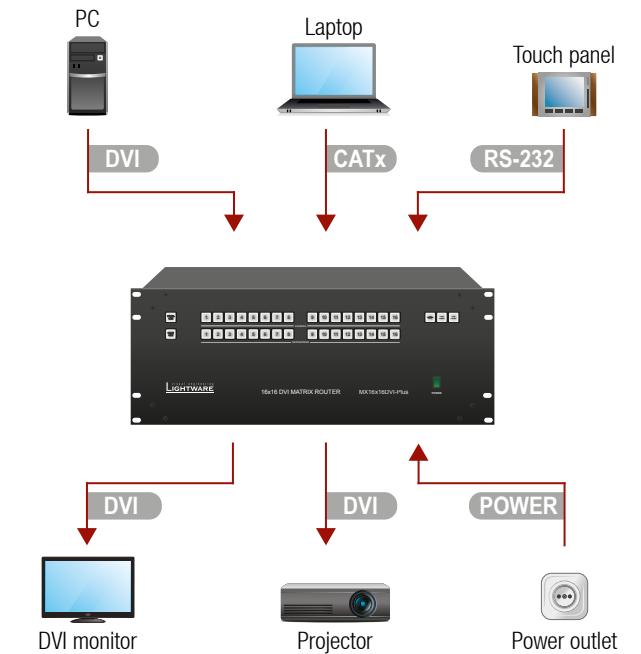

DVI Connect the desired sources to the **DVI input ports**.

DVI Connect the sink devices to the **DVI output ports**.

CATx In order to control the matrix via Ethernet, connect the device directly to a computer by the supplied cross-link cable, or to a LAN switch/router by a patch cable.

RS-232 Optionally connect a serial device (e.g. Touch panel) to the RS-232 port to send commands and control the matrix remotely.

POWER Connect the power cord to the AC power socket and to the matrix.

3

Product Overview

The following sections are about the physical structure of the device, input/output ports and connectors:

- ▶ [FRONT VIEW](#)
- ▶ [REAR VIEW](#)
- ▶ [ELECTRICAL CONNECTIONS](#)

3.1. Front View

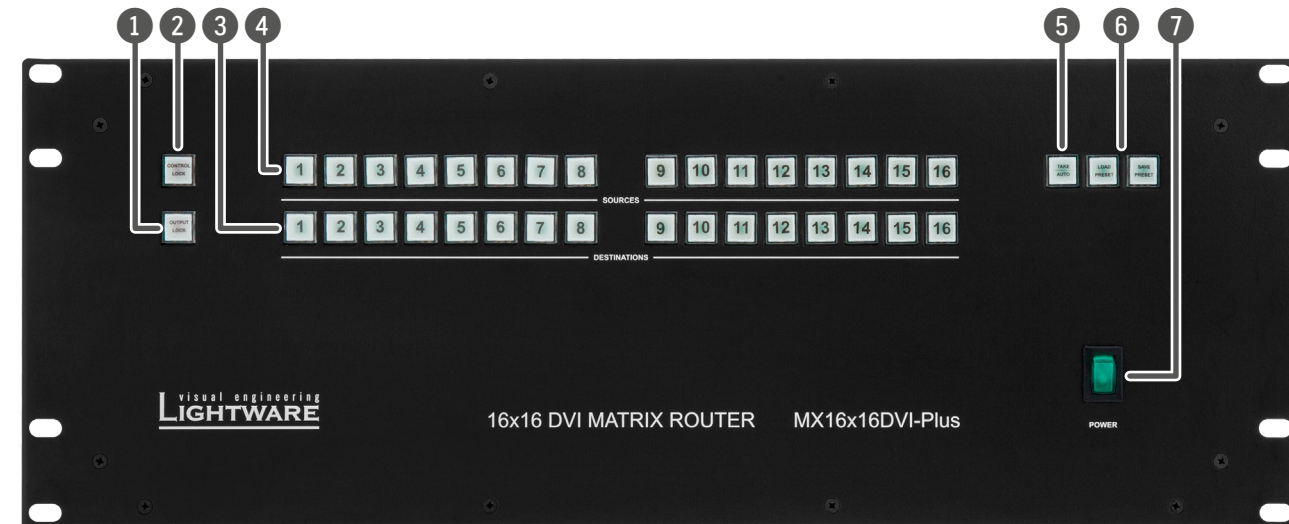

- | | | |
|---|-------------------------|---|
| ① | Output Lock | Locking one or more outputs. |
| ② | Control Lock | Disable or enable front panel operations. Red light means the switching and function buttons are disabled. |
| ③ | Destinations | Buttons to select an output or to view the state of an output. |
| ④ | Sources | Buttons to select an input, to select a preset number or to view the state of the selected input port. |
| ⑤ | Take/Auto Button | Switching between the working modes (Take / Autotake), execute input/output switching, or confirm a preset operation. |
| ⑥ | Preset Buttons | Loading and saving custom presets; a preset stores all input/output crosspoint and the muting states. |
| ⑦ | Power Switch | The matrix can be switched ON/OFF by the switch. |

3.2. Rear View

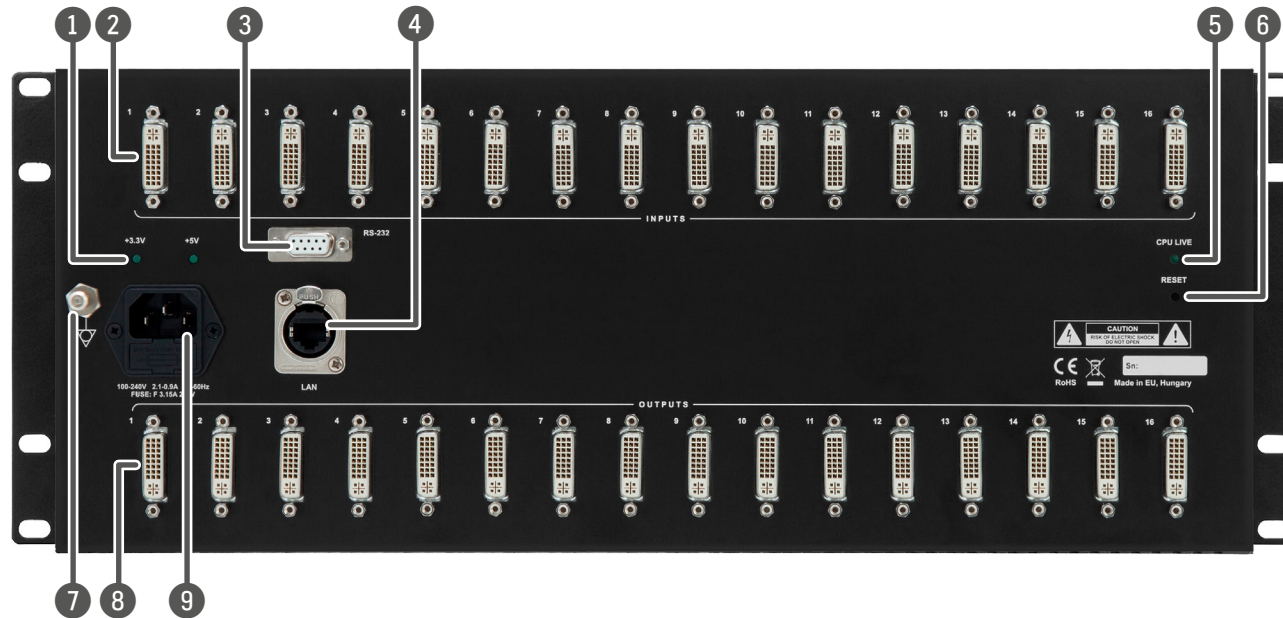

- 1 **DC Voltage Indicators** LED indicators for internal DC power voltages.
- 2 **Input Connectors** 29-pole DVI-I digital-only female receptacle connectors. Connect DVI source devices to these connectors.
- 3 **Serial Port** 9-pole D-SUB female connector for standard RS-232 interface. See more information in the [Serial Port](#) section.
- 4 **Ethernet Port** Locking RJ45 connector. Remote control port for connecting the unit to Local Area Network (LAN).
- 5 **CPU Live LED** The LED is blinking continuously if the CPU works properly.
- 6 **Reset Button** Resets all internal hardware elements and reboots the matrix.
- 7 **Equipotential Connector** Plug connector for potential equalization; see more information in the [Equipotential Connector](#) section.
- 8 **Output Connectors** 29-pole DVI-I digital-only female receptacle connectors. Connect DVI sink devices to these connectors.
- 9 **Power Connector** Standard IEC-320 C14 power connector for the power source.

3.3. Electrical Connections

DVI Inputs and Outputs

29 pole DVI-I connectors, however analog pins are not connected internally. This way, users can plug in any DVI connector, but keep in mind that analog signals (such as VGA or RGBHV) are NOT processed.



ATTENTION! Always use high-quality DVI cable for connecting sources and displays.

DVI Outputs

29 pole DVI-I connectors for outputs have only digital pins internally connected. This way, users can plug in any DVI connector, but keep in mind that analog signals (e.g. VGA or RGBHV) are NOT available on outputs.

Fiber Cable Powering

DVI outputs are able to supply 500 mA current on DDC +5V output (pin 14 on output connectors) which is sufficient to supply power to hybrid fiber optical DVI cables. Standard DVI outputs usually supply only 55 mA current on +5V output, thus unable to directly power a fiber optical cable.

ATTENTION! The matrix router does not check if the connected sink (monitor, projector or other equipment) supports Hotplug or EDID signals but outputs the selected signal immediately after the switch command.

Ethernet Port

The matrix can be controlled remotely via Ethernet as well; it can be connected to a LAN hub, switch or router with a UTP patch cable. Connect a cross UTP cable for a direct connection! The robust Neutrik EtherCON connector ensures reliable connection, however normal RJ45 connectors can be also used.



The Wiring of Twisted Pair Cables

Terminating the TP cables according to TIA/EIA T 568 A or TIA/EIA T 568 B standards is recommended.

Pin	TIA/EIA T568 A	Color and name	TIA/EIA T568 B	Color and name
1		white/green stripe		white/orange stripe
2		green solid		orange solid
3		white/orange stripe		white/green stripe
4		blue solid		blue solid
5		white/blue stripe		white/blue stripe
6		orange solid		green solid
7		white/brown stripe		white/brown stripe
8		brown solid		brown solid

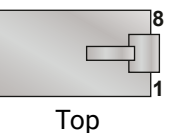
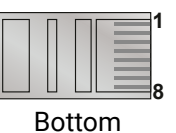
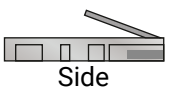

Serial Port

Lightware standalone DVI-Plus matrix routers can be controlled remotely through industry standard 9-pole D-SUB female connector located on the rear panel of the unit.

Pin nr.	RS-232 pinout
1	not connected
2	TX data transmit
3	RX data receive
4	DTR (Internally connected to Pin 6)
5	GND signal ground (shield)
6	DSR (Internally connected to Pin 4)
7	RTS (Internally connected to Pin 8)
8	CTS (Internally connected to Pin 7)
9	not connected

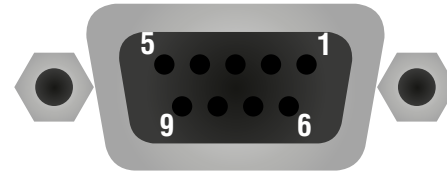

Equipotential Connector

The purpose of additional potential equalization is to equalize potentials between different metal parts that can be touched simultaneously or to reduce the potential differences which can appear during operation between the bodies of medical electrical devices and conductive parts of other objects. Ø6 mm plug made of nickel-plated brass can be found on the left side of the unit's back for potential equalization.

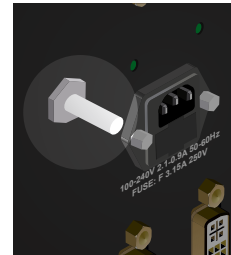

4

Operation

This chapter is about the powering and operating of the device describing the functions which are available by the front/rear controls:

- ▶ [POWERING ON](#)
- ▶ [BASIC CONTROL PANEL OPERATIONS](#)
- ▶ [THE EDID MEMORY OF A MATRIX](#)
- ▶ [REMOTE OPERATION](#)

4.1. Powering on

Connect the power cord to the AC power input connector. After switching the mains switch to upper position the matrix starts up. After powered on, the unit performs a self-test, and then all front panel buttons light up for a second. After the self-test the CPU live LED starts blinking, the matrix reloads its last configuration and it is ready to use.

ATTENTION! After switching ON, the matrix reloads the latest settings that were used before it was turned off. The matrix has an internal emergency memory that stores all current settings and tie configurations. This memory is independent from presets and invisible for the user. This built-in feature helps the system to be ready immediately in the case of a power failure or accidental power down.

4.2. Basic Control Panel Operations

4.2.1. CONTROL LOCK

DEFINITION: The **Control Lock** means to disable the front panel buttons.

While the front panel buttons are disabled the RS-232 and Ethernet control is still enabled. If the button is not illuminated, front panel button operations are enabled. If it illuminates red continuously, front panel operations are disabled.



Press and hold the **Control lock** button for 3 seconds to toggle the **Control lock** state.

4.2.2. Take / Autotake Modes

The router has two different switching modes: **Take** and **Autotake**. If the **Take / Auto** button is unlit, **Take** mode is active. When the **Take / Auto** button continuously lights green, **Autotake** mode is selected.

Press and hold the **Take** button for three seconds to toggle between **Take** and **Autotake** modes.

Take Mode

DEFINITION: The **Take** mode allows the user to connect or disconnect multiple outputs to an input at once but the layout must be confirmed (executed) by the **Take** button as a final step.



The commands are only executed when the **Take** button is pressed. If an operation is not confirmed by the **Take** button, all preselected actions will be ignored, and the router returns to its idle state.

Autotake Mode

DEFINITION: The **Autotake** mode means the switching actions are executed immediately (without user confirmation).



The switching occurs immediately upon pressing one of the input selector buttons. This mode is useful when time delay is not allowed between multiple switching.

4.2.3. Viewing the Crosspoint State

The user can check the current switching status on the front panel using front panel buttons. This status view feature is slightly different in **Take** or **Autotake** modes because of different switching philosophy of the two modes.

INFO: A status view occurs whenever the router has to be switched. After entering the view state, the user can change the routing configuration. Viewing and switching can be done after each other, or if nothing is pressed for three seconds, the router returns to idle state.

View Current State in Take Mode

If all source and destination buttons and **Take** button are dark (the unit is in **Take** mode, and no input was selected in last 3 seconds), the user can verify both input and output connections. This informative display will remain for 3 seconds, and then all button lamps go out. In **Take** mode no accidental change can be done unless **Take** button is pressed.

For viewing input connections, press and release a **source** button. Now the selected source button and all destination buttons will light up which are currently connected to the selected source.



For viewing output connections, press and release a **destination** button. Now the source button which is connected to the selected destination will light up. If no source button is lighting, the selected destination is in muted state.



View Current State in Autotake Mode

In **Autotake** mode only states of destinations can be viewed.

Press and release the required **destination** button. Now the source button which is connected to the selected destination will light up. If no source button is lighting, the selected destination is muted or disconnected. By pressing another **destination** button, the state of that destination can be seen.



ATTENTION! Be careful, as if a **source** button is pressed in Autotake mode, it is immediately connected to the last selected destination.

INFO: Muting or disconnecting an output cannot be done in **Autotake** mode.

4.2.4. Switching

Changing Connections in TAKE Mode

Step 1. Press and release the desired **source** button. The pressed source button and all destination buttons which are currently connected to this source will light up. This is an informative display about the current status of the selected input (view only).



Step 2. Press and release the desired **destination button(s)** which has to be connected to the selected source. The preselected destination button(s) start(s) blinking.



Step 3. Press and release the **Take** button to execute switching. Now the selected input is switched to the selected output or to the multiple outputs.



ATTENTION! A **source** button can be pressed twice to preselect all outputs. Outputs which are connected to the pressed input light up and all other outputs start to blink. Some outputs can be unselected if needed, and then pressing **Take** executes the switching.

INFO: If the pressed destination is locked then it could not be selected. This is indicated by a short flash of the **Output lock** when a locked destination is pressed.

Disconnecting or Muting in Take Mode

Step 1. Press and release the selected **source** button.



The pressed source button and all destination buttons which are currently connected to this source will light up.

Step 2. Press and release the desired green lighting **destination** button. The pressed destination or multiple destinations will turn dark.



Step 3. Press and release **Take** button to execute disconnection.



INFO: Deselected destinations are disconnected from any source, thus output devices will display black image or **no signal** message, or automatically will turn off.

Creating a Connection in Autotake Mode

Step 1. Press and release the desired **destination** button.

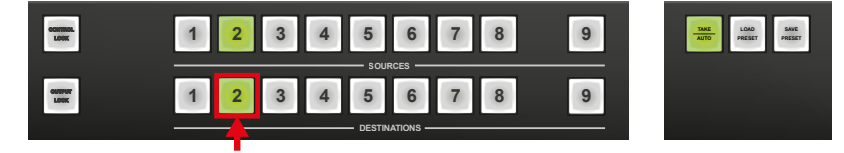

The pressed destination button and the actually connected source button light up green. If no source is connected (the output is muted) no source button will light up.

Step 2. Press and release the desired **source** button.



Switching is executed immediately. Switching between sources to the selected destination can be done directly.

Disconnecting or Muting in AUTOTAKE Mode

To prevent accidental muting this action is inhibited (disabled) in **Autotake** mode. Pressing a **source** button twice would cause accidental disconnecting.

4.2.5. Switching Operations Flowchart

Take Mode

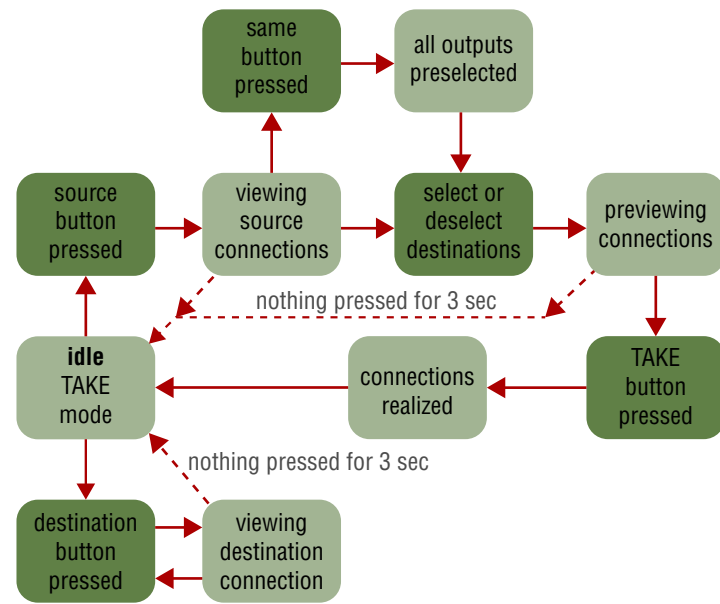

Autotake Mode

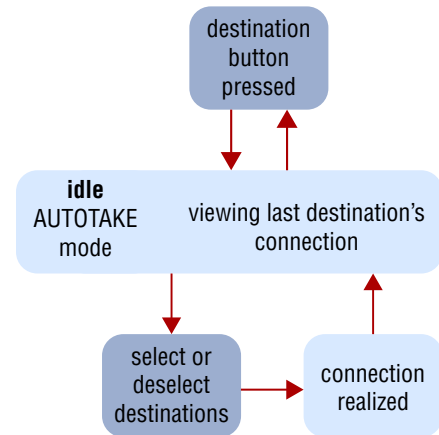

4.2.6. Preset Operations

DEFINITION: A **preset** stores a configuration regarding all input connections and mute state for all outputs.

INFO: All Lightware matrix routers have 32 user programmable presets. All presets are stored in a non-volatile memory; the router keeps presets even in the case of a power down. Memory numbers are assigned to the source buttons. The higher numbered presets are accessible only through software control.

Saving a Preset in Take Mode

Step 1. Create the desired connections which have to be saved.

Step 2. Press and release the **Save preset** button.



Step 3. Press and release a **source** button according to the desired memory address.



Step 4. Press and release the **Take** button.



Now the current configuration is stored in the selected memory.

ATTENTION! Preset save action always stores the current configuration for all outputs including mute state, but ignoring lock state.

Loading a Preset in Take Mode

Step 1. Press and release the **Load Preset** button.



Step 2. Press and release a **source** button according to the desired memory address.



Step 3. Press and release the **Take** button.



Now the selected preset is loaded.

ATTENTION! Loading a preset modifies all output states that are not currently locked.

Saving a Preset in Autotake Mode

Step 1. Create the desired connections which have to be saved.

Step 2. Press and release **Save Preset** button.



Step 3. Press and release a **source** button according to the desired memory address.



Now the current configuration is stored in the selected memory.

ATTENTION! Preset save action always stores the current configuration for all outputs including mute state, but lock state is ignored.

Loading a Preset in Autotake Mode

Step 1. Press and release **Load Preset** button.



Step 2. Press and release a **source** button according to the desired memory address.

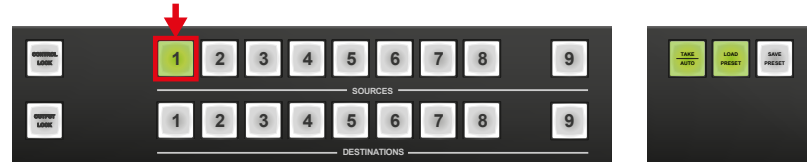

Now the selected preset is loaded.

ATTENTION! Loading a preset modifies all output states that are not currently locked.

4.2.7. Output Lock

DEFINITION: The **Output lock** means that an input port is locked to an output port and no input change or muting can be executed on that particular output port.



Using Lightware routers it is possible to lock a destination's state. This feature prevents an accidental switching to the locked destination in the case of an important signal. Destinations can be independently locked or unlocked. Locking a destination does not affect other destinations.

View Locked Outputs in Take Mode

Step 1. Press and release the **Output Lock** button.



Step 2. The **Output Lock** button starts to blink and all the buttons of any locked destinations light up and remain illuminated for three seconds.

Locking an Output in TAKE Mode

Step 1. Press and release the **Output Lock** button.



Now the **Output Lock** button starts to blink and the buttons of all the locked **outputs** illuminate green (view state). If no button is pressed for three seconds the router returns to idle state.

Step 2. Press the desired **output** buttons.



If an unlit output button is pressed it starts to blink indicating that it is preselected, for output locking.

Step 3. Press and release the **Take** button.



The selected destinations are now locked.

Unlocking an Output in Take Mode

Step 1. Press and release the **Output Lock** button.



Now the **Output Lock** button starts to blink and all the locked output's buttons illuminate green (view state). If no button is pressed for three seconds, the router returns to idle state.

Step 2. If an illuminating **output** button is pressed, it goes off, to indicate that it is preselected for unlocking.



Step 3. Press and release the **Take** button.



The deselected destinations are now unlocked.

View Locked Outputs in Autotake Mode

In **Autotake** mode a destination is selected all the time. Therefore the currently selected output and input buttons are illuminated. The **Output Lock** button illuminates regarding the lock state of the current output.

Viewing all locked outputs is not possible in **Autotake** mode, as pressing the **Output Lock** button instantly locks or unlocks the current output.

Locking an Output in Autotake Mode

Step 1. Press and release the required **destination** button.



Now the selected destination button and the currently configured source button light up (view mode).

Step 2. Press and release the **Output Lock** button.



Now the **Output Lock** button lights up in red, and lock function is activated at once. No source can be changed at the locked destination.

Unlocking an Output in Autotake Mode

Step 1. Press and release the required **destination** button which was previously locked.



Now the selected destination button and the currently configured **source** button and the **Output Lock** button light up.

Step 2. Press and release the **Output Lock** button (deselection).



Now the **Output Lock** button turns off and the port has been unlocked.

4.3. The EDID Memory of a Matrix

The EDID memory is non-volatile and consists of four blocks, each for a different purpose. These blocks are:

- **Factory preset EDIDs**
- **User saved EDIDs**
- **Dynamic EDIDs** (EDID of last connected sink on an output port)
- **Emulated EDIDs** (EDID currently emulated on an input port)

EDIDs are numbered from 1 in each block, and they can be referred as the first letter of the block name and the number of the desired EDID. This way F02 refers to the second factory preset EDID and D15 refers to the display device’s EDID on output 15.

Dynamic and emulated EDID blocks’ size adapts to the frame size. The memory structure is as follows:

- F01..F50 Factory Preset EDIDs (not editable)
- U01..U50 User programmable memories
- Monitor1..Monitor16 Last attached monitor’s EDIDs (outputs)
- Input1..Input16 Emulated EDIDs (inputs)

All EDIDs (including factory preset; user programmable memories; EDID at other inputs; and EDID at outputs) can be switched and emulated at any of the inputs.

ATTENTION! The attached monitor’s EDID is stored automatically until a new monitor is attached to that particular output. In the case of powering the unit off, the last attached monitor’s EDID remains in non-volatile memory even is the monitor is unconnected.

INFO: The Controller can handle both 128 Byte EDID and 256 Byte extended EDID structures.

4.3.1. EDID Types

Most of the factory preset EDIDs include only one resolution. This is to force the connected source to give a signal with the needed resolution. However there are Universal EDIDs as well which allow many resolutions. The factory EDIDs are divided into groups regarding their type. Some EDIDs are supporting DVI only, some support HDMI, and some are for analog VGA signals. Also, there are some EDIDs for Dual Link DVI resolutions. See the list of factory EDIDs in the [Factory EDID List](#) section.

DVI EDIDs does not support audio. The Universal DVI EDID indicates support for many PC (VESA) resolutions.

HDMI EDIDs support embedded audio. These EDIDs have PCM stereo audio format enabled. To allow other audio formats like Dolby and DTS, special EDIDs have to be used. There are three Universal HDMI EDIDs which include the same resolutions but support different capabilities.

4.4. Remote Operation

Lightware DVI-Plus matrix routers can be controlled through various interfaces remotely. The feature allows functions which are not accessible via the front panel and useful for system integrators and operators to control multiple devices in a complicated system through a single user interface.

4.4.1. Control Interfaces

The user can connect to the matrix through

- Ethernet (TCP/IP),
- Serial port (RS-232 or RS-422),

After establishing the connection, there is no difference between the connection types. The available remote connections and the relating chapters are listed below.

User Interface	Connection Type			Further Information
	Ethernet Port	RS-232 Serial Port	USB Port	
Built-in website	✓	-	-	Chapter 5
Lightware Device Controller software	✓	✓	✓	Chapter 6
Third party control system	✓	✓	-	Chapter 7

ATTENTION! Ethernet port can be connected to a LAN hub, switch or router with a UTP patch cable. If connecting to a computer directly, a cross-link UTP cable has to be used!

User Interface Comparison

The built-in website and Lightware Device Controller have similar capabilities. Differences and features are described in below table.

Function	Lightware Device Controller Software	Built-in Website
Platform	Windows, Mac OS X	Mozilla Firefox, Apple Safari, Google Chrome
Installation	installation required	web browser needed only
I/O crosspoint switch	✓	✓
I/O and preset names	✓	✓
Preview presets	✓	✓
Easy EDID creator	✓	✓
EDID editor	✓	✓
EDID load / save	✓	✓*

* The feature is not supported by Apple Safari browser.

4.4.2. Multiple Simultaneous Connections

The matrix allows simultaneous remote control over multiple interfaces. External control over Ethernet and Serial connections can be used at the same time. Moreover, the Ethernet interface can handle multiple connections on the same TCP/IP port.

The responses to the commands are only sent to the interface on which they were queried – except responses to crosspoint switch, mute/unmute, lock/unlock and preset setting commands, which are always sent. The feature allows to operate more controllers without interfering each other but keeping the crosspoint state synchronized. If different protocols are used, then the responses to crosspoint commands are translated to the proper form.

4.4.3. IP Settings

The Ethernet port can be configured remotely through Controller software or the built-in website. The factory default IP settings or DHCP mode can be activated quickly through front panel shortcut buttons. To reset the IP configuration perform the following:

Resetting the IP Address

Reset to factory default IP configuration or to DHCP mode with front panel buttons.

Step 1. Switch the router to **Take** mode if used previously in **Autotake** mode by pressing **Take** button for 3 seconds (light will go off).



Step 2. Press the **Control Lock** button (Control Lock button lights in up red continuously).



Step 3. Press and keep pressed the **Output Lock** button (the current protocol indication will light up).



Step 4. Press and release the

a) **Load Preset** button to set the factory default IP settings:

- IP address: 192.168.254.254
- port number: 10001
- subnet mask: 255.255.0.0
- gateway: 0.0.0.0



b) **Save Preset** button to set DHCP enabled:

- IP address: Acquired with DHCP
- port number: unchanged
- subnet mask: Get from DHCP server
- gateway: Get from DHCP server



Step 5. A light sequence will occur to confirm the command. (Take/Auto, Load Preset and Save Preset buttons will light up one after the other.)

Step 6. Connect the LAN cable to the Ethernet port if it was unplugged.

Step 7. Wait about 20 seconds before connecting to the matrix.

4.4.4. Serial Port Settings

DVI-Plus matrix routers can be ordered with either RS-232 or RS-422 communication port. The port settings are done in the factory. The device uses standard RS-232 interface with the following default settings:

57600 Baud, 8 data bit, 1 stop bit, no parity

4.4.5. Control Protocols

Matrix routers can be controlled with multiple control protocols. Lightware routers have a special protocol, but to inter-operate with third-party devices, a secondary protocol is also provided.

ATTENTION! Be aware that different control interfaces can be set to use different protocols. E.g. Lightware protocol is set on Ethernet interface while Protocol #2 is set on the Serial interface at the same time. Lightware Device Controller software and the built-in website works only with LW protocol (#1)!

INFO: The communication protocol of the USB interface (Lightware protocol) cannot be changed.

The currently used protocol can be viewed or changed any time on the matrix front panel or by protocol commands.

Changing (displaying) the Current Protocol on the Front Panel

Step 1. Switch the router to **Take** mode; if **Autotake** mode was active press the **Take** button for 3 seconds. (The backlight will go off.)



Step 2. Press and release the **Control Lock** button (it lights in up red continuously).



Step 3. Press and keep pressed the **Output Lock** button, the button will light in red. The active protocol is indicated:



- a) **Source#1 lights:** Lightware protocol active
- b) **Source#2 lights:** Protocol#2 is active

Step 4. Changing/Viewing:

- a) Release the **Output Lock** button to keep the current protocol.
- b) If you want to change the protocol keep the **Output Lock** button pressed, and press the desired **Source** button.

Changing (displaying) the Current Protocol via Remote Connection

Connect to the matrix through any control interface, then use the commands described in the [Setting the Current Protocol](#) section.

5

Software Control - The Built-in Web

The DVI-Plus matrix frames contains a feature which allows to connect and control the matrix via a web browser. The built-in web offers you full control over all settings even if you do not have the opportunity to install new programs.

- ▶ ESTABLISHING THE CONNECTION
- ▶ CONTROL MENU
- ▶ EDID MENU
- ▶ STATUS MENU
- ▶ CONFIGURATION MENU
- ▶ TERMINAL MENU

5.1. Establishing the Connection

To access the web page just run your preferred web browser and type the IP address of the matrix as an URL. The computer and the matrix must be in the same subnet.

ATTENTION! Only one opened web page is allowed at once. Other TCP/IP connections are prohibited while the web page is opened.

IP Address

The only way to find out the IP address of the matrix (if it is not known) is to search for devices with the Lightware Device Controller software. If this is not possible for some reason, the IP address can be reset to factory default (192.168.254.254) with the front panel buttons, see the [IP Settings](#) section.

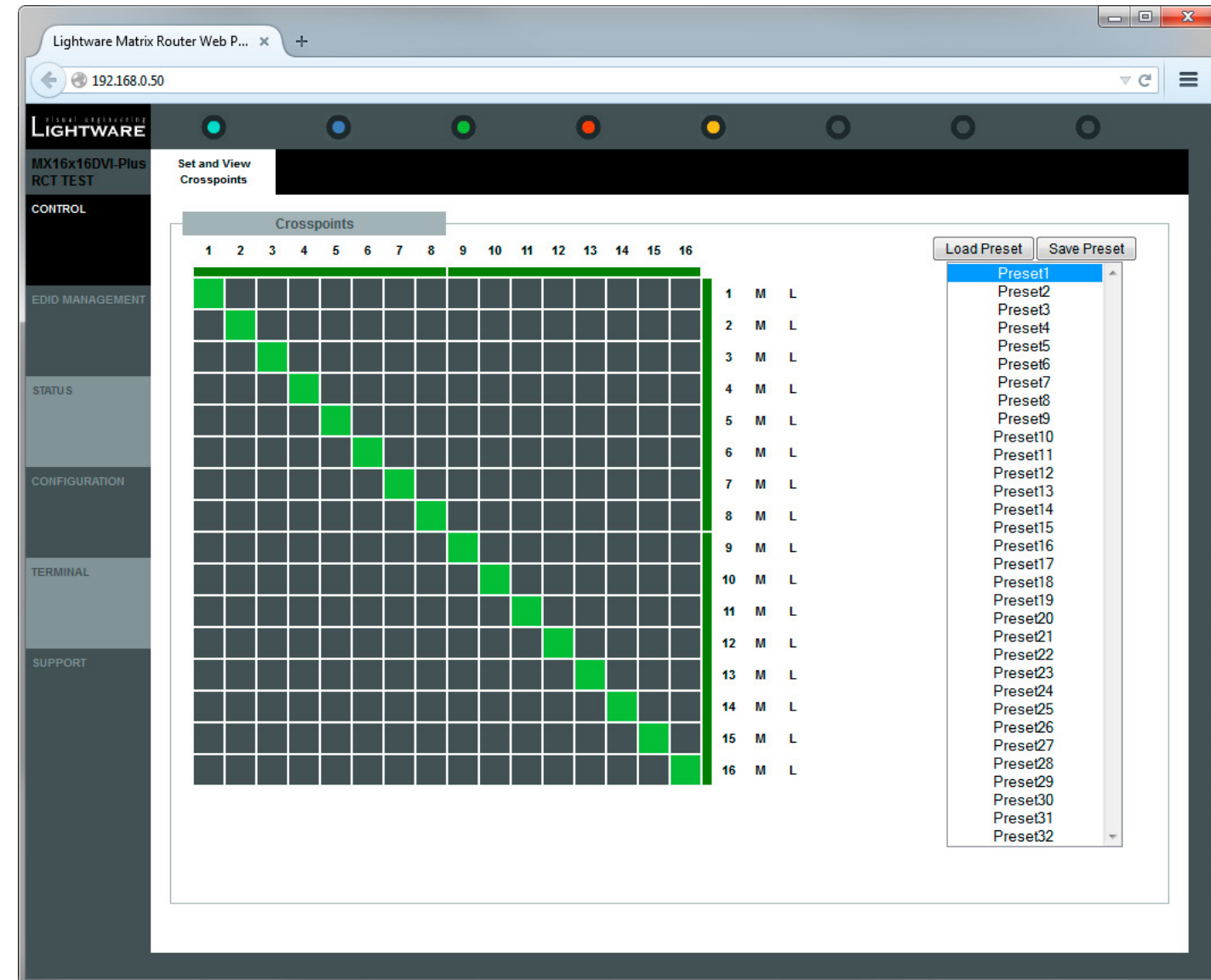

The Crosspoint Menu (default screen)

TIPS AND TRICKS: To get the best visibility of the screenshots in this chapter adjust the zoom setting of your PDF Reader software to 150% magnification.

5.2. Control Menu

5.2.1. Crosspoint Switching

After connecting to a new device, this menu appears by default. 1; 2; 3... columns represent the inputs, and the 1; 2; 3... rows represent the outputs. Each green square represents a live connection. Click on the desired grey square to make the connection. When the mouse pointer hovers over the array, the corresponding input and output numbers are highlighted in red to help to switch.

5.2.2. Muting the Outputs

Outputs can be easily muted by clicking the button titled 'M' beside the output. This means that no signal will be present at this output. If muting is active the background turns to black.

5.2.3. Locking the Outputs

Outputs can be locked to any inputs. After locking an input to an output no switching is permitted for that output unless it is unlocked again. If the port is locked, the background turns to red.

ATTENTION! Loading a preset does not change either the lock state or the switch state of a locked output. If an output was locked to an input before preset loading, it will also be locked that input after preset loading, so locked outputs ignore the preset.

5.2.4. Preset Operations

Preset operations can be done in the right panel of the Control / Set and View Crosspoints page. Lightware matrix routers have 32 preset memories which can be loaded and saved any time.

INFO: A preset setting stores a full configuration of all outputs, so preset loading have an effect on every output, except the locked ones.

Saving a Preset

- Step 1.** Arrange the desired configuration on matrix switching area.
- Step 2.** Select the desired **preset memory** location.
- Step 3.** Press the **Save Preset** button. A message box confirms that the preset is stored.

Loading a Preset

- Step 1.** Select the preset **memory location** (Preset1...Preset32) you want to load as next configuration.
- Step 2.** Press the **Load Preset** button. Now the preset is loaded
- Step 3.** The new I/O configuration is displayed on the matrix switching area.

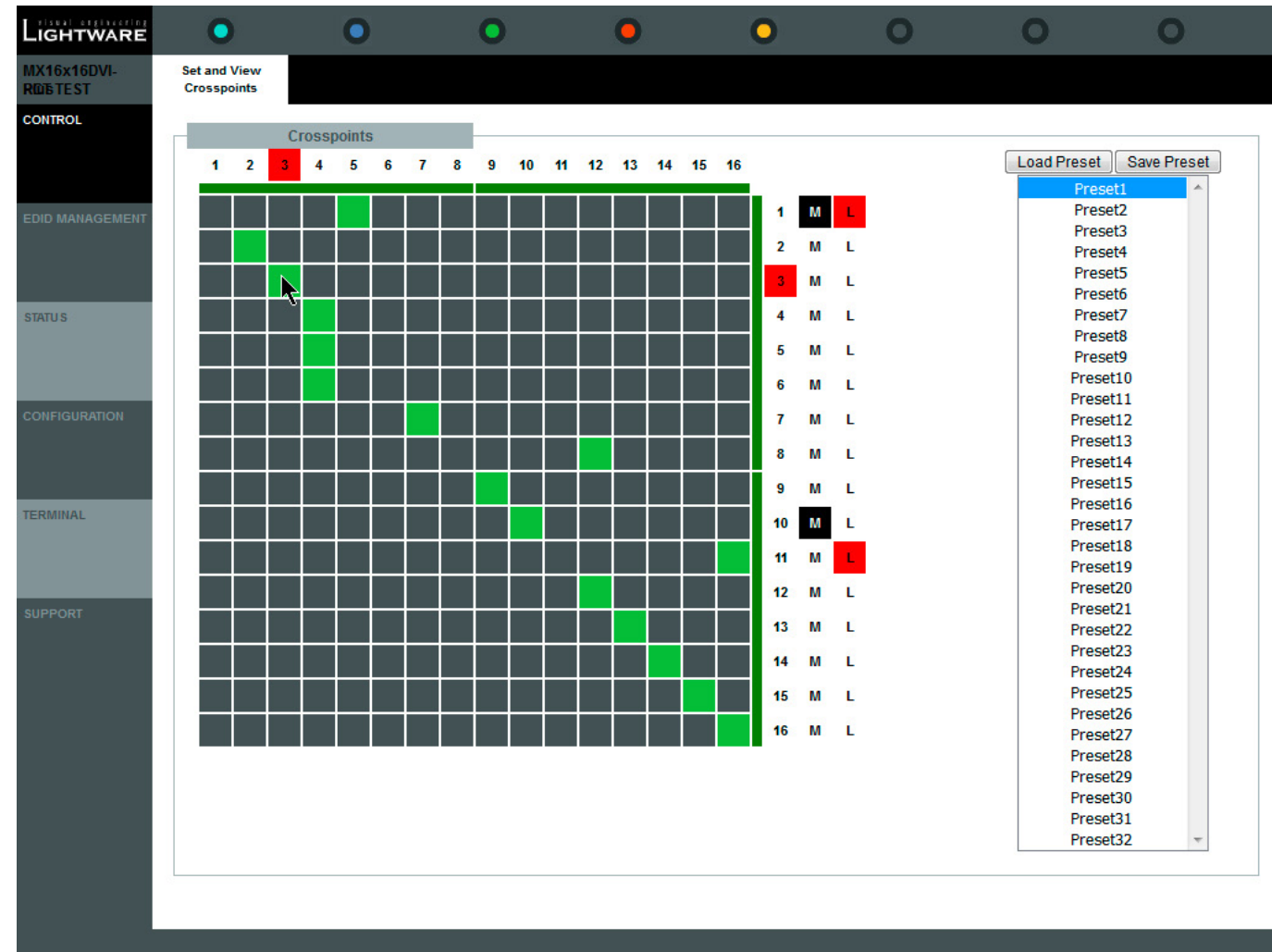

The Crosspoint Menu

5.3. EDID Menu

By clicking on the **EDID Management** menu, the **EDID Routing** page appears.

When the user enters the menu at the first time, the whole EDID list is being downloaded from the matrix which may take up to 40 seconds.

The lists of the EDIDs

- **Emulated EDID List:** the resolutions and the vendor names of the EDID reported to the source for each input separately.
- **Last attached Monitor's EDID List:** the resolutions and vendor names of the display devices connected to matrix switcher's output.
- **Factory EDID List:** shows the factory memory locations (01# - 50#) with preprogrammed EDID.
- **User EDID List:** shows the memory locations (51# - 100#) which can be used by the user to save custom EDIDs.

5.3.1. Changing the Emulated EDID at One or All Inputs

Step 1. Select the **Emulated EDID List** in one of the window areas in the drop down list.

Step 2. Select the desired **EDID list** in the other window.

Step 3. Select the desired **EDID** from this list with a left mouse click, a popup message appears. (Memory location, manufacturer, Resolution and Monitor name of the selected EDID).

Step 4. Click on the desired **memory location** in the Emulated EDID List window or the Switch to all input button. Now the EDID has been changed on selected input. If the EDID changing was successful a response message will appear on the bottom of the page.

Step 5. Click on the **Cancel** button to exit EDID changing.

INFO: Switching an EDID to ALL inputs may take some seconds.

The user can switch and learn EDIDs also in the Last Attached Monitors EDIDs window. Switching an EDID from this list to an input results dynamic EDID routing. This means that the emulated EDID changes automatically if a new monitor is attached to the output, by simply copying the data from the monitor.

The screenshot displays the 'EDID Routing' page in the Lightware control interface. It features two side-by-side tables for managing EDID data.

Emulated EDID List				Last Attached Monitor's EDID List			
EDID Inputs	Manufacturer	Resolution	Monitor Name	EDID Outputs	Manufacturer	Resolution	Monitor Name
Input 1	DEL	2560x1440@59.94Hz	Input_1	Monitor 1	DEL	1920x1200@59.94Hz	DELL 3008WFP
Input 2	DEL	2560x1440@59.94Hz	Input_2	Monitor 2	LWR	640x480@60.0Hz	D640x480p60
Input 3	DEL	2560x1440@59.94Hz	Input_3	Monitor 3	VSC	1600x1200@60.0Hz	VP2030 SERIES
Input 4	DEL	2560x1440@59.94Hz	Input_4	Monitor 4	LWR	640x480@60.0Hz	D640x480p60
Input 5	DEL	2560x1440@59.94Hz	Input_5	Monitor 5	LWR	640x480@60.0Hz	D640x480p60
Input 6	DEL	2560x1440@59.94Hz	Input_6	Monitor 6	LWR	640x480@60.0Hz	D640x480p60
Input 7	DEL	2560x1440@59.94Hz	Input_7	Monitor 7	LWR	640x480@60.0Hz	D640x480p60
Input 8	DEL	2560x1440@59.94Hz	Input_8	Monitor 8	ACR	3840x2160@59.99Hz	S277HK
Input 9	DEL	2560x1440@59.94Hz	Input_9	Monitor 9	LWR	640x480@60.0Hz	D640x480p60
Input 10	DEL	2560x1440@59.94Hz	Input_10	Monitor 10	LWR	640x480@60.0Hz	D640x480p60
Input 11	DEL	2560x1440@59.94Hz	Input_11	Monitor 11	LWR	640x480@60.0Hz	D640x480p60
Input 12	DEL	2560x1440@59.94Hz	Input_12	Monitor 12	LWR	640x480@60.0Hz	D640x480p60
Input 13	DEL	2560x1440@59.94Hz	Input_13	Monitor 13	LWR	640x480@60.0Hz	D640x480p60
Input 14	DEL	2560x1440@59.94Hz	Input_14	Monitor 14	LWR	640x480@60.0Hz	D640x480p60
Input 15	DEL	2560x1440@59.94Hz	Input_15	Monitor 15	LWR	640x480@60.0Hz	D640x480p60
Input 16	DEL	2560x1440@59.94Hz	Input_16	Monitor 16	NEC	1920x1080@60.0Hz	24WVGX3

At the bottom of the interface, there are two buttons: **SWITCH TO ALL INPUT** and **CANCEL**.

The EDID Management Menu

5.4. Status Menu

Basic device information, such as the installed cards' firmware and hardware revisions are displayed in this window.

5.4.1. Generating a Standard Report

The built-in website allows the user to generate a standard report file which can be used when troubleshooting (e.g. contacting Lightware Support). The file contains basic information about the health and the version numbers of the matrix:

- Current command protocol
- The equipment type and serial number
- Status of input/output ports
- Installed controllers and I/O board types and firmware with versions
- Network settings
- All EDID headers and status (emulated, dynamic, factory, user)

The steps are the followings:

Step 1. Click on the **Generate report file** button to start the process; a red **Generating report...** message will appear.

ATTENTION! Let the device finish the process! Do not exit/select another menu item.

Step 2. After finishing a message will appear. Click on this message to download the report file to the computer.

Step 3. Select the desired location and click on the **Save** button. The default file name is:
Lightware_matrix_standard_report_devicename_serial_date_time_.txt

5.4.2. Generating a Custom Report

The built-in website can run a special command file. After running, a new report file is generated which is useful for Lightware Support Team when debugging. If you have received the command file please do the followings:

Step 1. Save it to the computer.

Step 2. Click on the **Browse...** button or on the **No file selected** text. The **File upload** window will open.

Step 3. Select the command file; the generating will start automatically.

Step 4. During the process a red **Generating report...** message will appear.

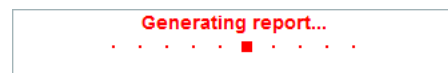

System Status

Device Information

Device:	MX16x16DVI-Plus
Serial Number:	RCT TEST
MAC address:	00-20-4A-E3-1F-93

Installed Cards

Slot Name	Card Name	Firmware Version	Hardware Version
CPU Card	MX-CPU	FW:2.5.0	
Control Panel	MX-CP	FW:1.0.8	
CPU Card	MX-DVI-EDID	FW:3.3.4	
MOTHERBOARD	MX16X16DVI-PLUS		SCH_2.5 PCB_2.5
SLOT 1	MX16X16DVI-PLUS-OB		SCH_2.5 PCB_2.5
SLOT 2	MX16X16DVI-PLUS-OB		SCH_2.5 PCB_2.5
SLOT 3	MX16X16DVI-PLUS-IB		SCH_2.5 PCB_2.5
SLOT 4	MX16X16DVI-PLUS-IB		SCH_2.5 PCB_2.5
CPU Card	Web Content	FW:1.4.1	
CPU Card	Web Server	FW:1.1.5	

Router Status

3.3V	N/A
5V	N/A
12V	N/A
Temp	N/A
Fan1	N/A
Fan2	N/A

Report

Generate report file Custom report: No file selected.

The Status Menu

ATTENTION! Let the device finish the process! Do not exit/select another menu item.

Step 5. When the generating is finished a red message will appear.

**The report is now ready.
Click HERE to download it.**

Click on that **message** to download the report file to the computer. A browser window will open.

Step 6. Select the desired location and click on the **Save** button. The default file name is:

Lightware_matrix_standard_report_devicename_serialnumber_date_time_.txt

5.5. Configuration Menu

The network settings of the matrix are displayed under the Configuration menu.

INFO: Factory default IP settings can be reloaded by the front panel buttons. See the [IP Settings](#) section.

5.5.1. Automatic IP Address Configuration

The matrix switcher supports three of the most used automatic IP configuration protocols. To assign IP address automatically do the followings:

Step 1. Click on the **Configuration** menu.

Step 2. Select the **Obtain IP address automatically** option.

Step 3. Enter the following (as necessary):

- **BOOTP:** Select **Enable** to permit the Bootstrap Protocol (BOOTP) server to assign the IP address from a pool of addresses automatically.
- **DHCP:** Select **Enable** to permit the Dynamic Host Configuration Protocol (DHCP) server to assign leased IP address to the matrix unit automatically.
- **AutoIP:** Select **Enable** to permit the matrix to generate an IP in the 169.254.x.x address range with Class B subnet.

ATTENTION! Disabling BOOTP, DHCP, and AutoIP (all three checkboxes) is not advised as the only available IP assignment method will then be ARP or serial port.

Step 4. When you are finished, click on the **Apply Settings** button.

INFO: To continue using the built-in website, you have to type the IP address in your browser.

5.5.2. Static IP Address Configuration

The user can manually assign an IP address to the matrix and enter the related network settings. Assign an IP address manually:

Step 1. Click on **Configuration** menu.

Step 2. Select **Fix IP Configuration**.

Step 3. Enter the followings (if necessary):

- **IP Address:** If DHCP is not used to assign the IP addresses, enter it manually in decimal-dot notation. The IP address must be set to a unique value in the network.
- **Subnet Mask:** A subnet mask defines the number of bits taken from the IP address that was assigned for the host part.

The Configuration Menu

- **Default Gateway:** The gateway address or router allows communication to another LAN segment. The gateway address should be the IP address of the router connected to the same LAN segment as the matrix. The gateway address must be within the local network.

Step 4. When you are finished, click on the **Apply Settings** button.

INFO: To continue using the built-in website, you have to type the IP address in your browser.

5.5.3. Loading the Default IP Settings

Step 1. Click on the **Load Default** button. Now the factory default IP address, Subnet Mask and Gateway address is loaded into the input boxes. But they are not saved.

Step 2. To save the settings, click on the **Apply Settings** button.

Step 3. The default fix IP settings are applied:

- IP Address: 192.168.254.254,
- Subnet Mask: 255.255.0.0,
- Default Gateway: 0.0.0.0.

5.5.4. TCP Port Configuration

The user can configure the TCP port number, which is used to communicate with the matrix via LAN. The input box initially contains the current setting.

Step 1. Type the desired **TCP port number** into the input box.

Step 2. Press the **Apply Settings** button. The new port will be active after the next connection.

5.5.5. Loading the Default TCP Port Settings

Step 1. Click on **Load Default** button. Now the factory default value is in the input box, but it is not saved.

Step 2. Click on **Apply Settings** button to save the settings. The new port will be active after the next connection.

5.6. Terminal Menu

This general-purpose web terminal is intended mainly for test and debugs purposes. All commands can be used here which can be found in the [Programmers' Reference](#) chapter. The text can be typed directly into the textbox.

Commands are automatically surrounded by framing brackets (default setting). Every sent command and every received response gets an arrow prefix (-> or <-), and displayed in different font colors in order to help to distinguish.

If the **Command framing** checkbox is unchecked, you can send multiple commands together, however, in this case, you have to type in the framing brackets manually.

If the **Autoscroll** checkbox is unchecked user should use the scroll bar to see the last commands.

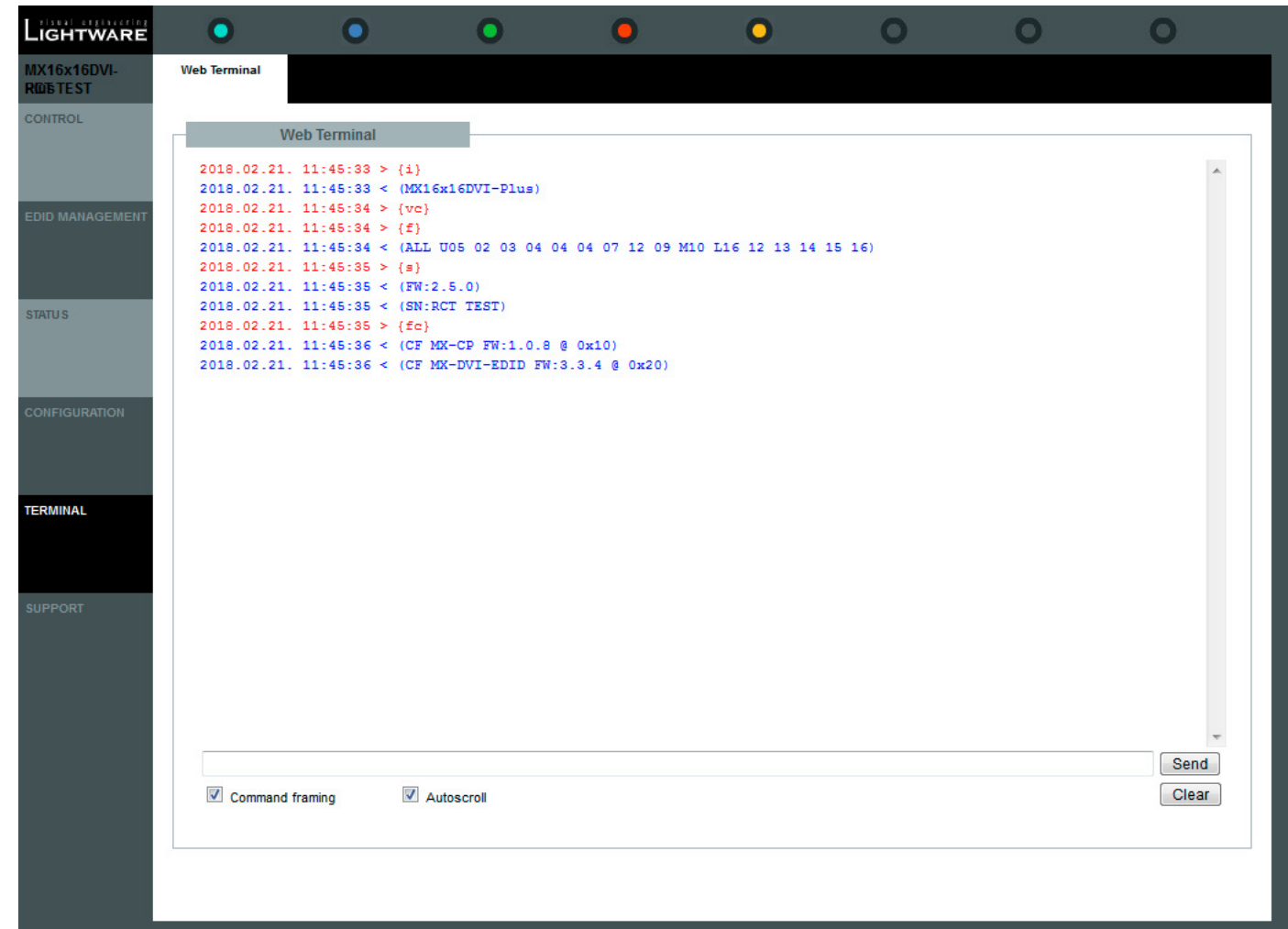

The Terminal Menu

6

Software Control – Lightware Device Controller Software

The matrix can be controlled by a computer through the USB, RS-232, and Ethernet port using Lightware Device Controller (LDC). The software can be installed on a Windows PC or Mac OS X. The application can be downloaded from www.lightware.com. The Windows and the Mac versions have the same look and functionality.

- ▶ [INSTALL AND UPGRADE](#)
- ▶ [RUNNING THE LDC](#)
- ▶ [CONNECTING TO A DEVICE \(DEVICE DISCOVERY WINDOW\)](#)
- ▶ [THE CROSSPOINT MENU](#)
- ▶ [TILE VIEW](#)
- ▶ [EDID MENU](#)
- ▶ [SETTINGS MENU](#)
- ▶ [TERMINAL WINDOW](#)

6.1. Install and Upgrade

INFO: After the installation, the Windows and the Mac application has the same look and functionality. This type of the installer is equal with the Normal install in the case of Windows and results an updateable version with the same attributes.

Installation for Windows OS

Run the installer. If the User Account Control drops a pop-up message click Yes. During the installation you will be prompted to select the type of the installation: normal and the snapshot install:

Normal install	Snapshot install
Available for Windows and Mac OS X	Available for Windows
The installer can update only this instance	Cannot be updated
Only one updateable instance can exist for all users	More than one different version can be installed for all users

Comparison of the Installation Types

ATTENTION! Using the Normal install as the default option is highly recommended.

Installation for Mac OS X

Mount the DMG file with double clicking on it and drag the LDC icon over the Applications icon to copy the program into the Applications folder. If you want to copy the LDC into another location just drag the icon over the desired folder.

The Upgrading of the LDC

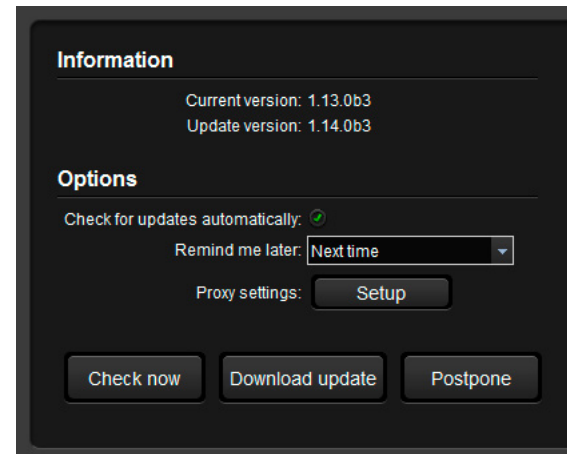

TIPS AND TRICKS: To get the best visibility of the screenshots in this chapter adjust the zoom setting of your PDF Reader software to 150% magnification.

Step 1. Run the application.

The **Device Discovery** window appears automatically and the program checks the available updates on Lightware's website and opens the update window if the LDC found updates. The current and the update version number can be seen at the top of the window and they are shown in this window even with the snapshot install. The **Update** window can be also opened by clicking the **?** (About) and the **Update** button.

Step 2. Set the desired update setting in the **Options** section.

When the Check for updates automatically option is selected, the LDC tries to find a new version after startup. The update can be postponed by setting a reminder; use the drop down list. The proxy settings can be set in a separate window.

Step 3. Click the **Download update** button to start. The updates can be checked manually by clicking the **Check now** button.

6.2. Running the LDC

The common way to start the software is double-click on the LDC icon. But the LDC can be run by command line parameters as follows:

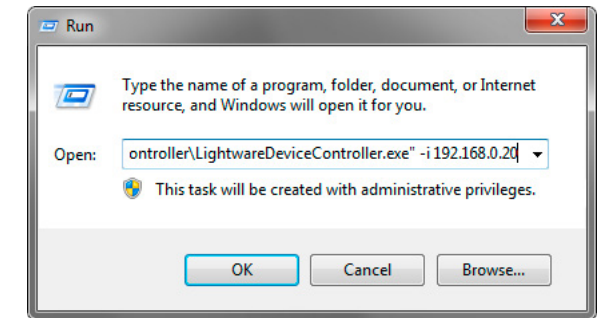

Connecting to a Device with Static IP Address

Format: LightwareDeviceController -i <IP_address>:<port>

Example: LightwareDeviceController -i 192.168.0.20:10001

The LDC is connected to a device with the indicated static IP address directly; the Device Discovery window is not displayed. When the port number is not set, the default port is used: 10001 (LW2 protocol). For LW3 devices use the 6107 port number.

Connecting to a Device via a Serial Port

Format: LightwareDeviceController -c <COM_port>:<Baud>

Example: LightwareDeviceController -c COM1:57600

The LDC is connected to a device with the indicated COM port directly; the Device Discovery window is not displayed. If no Baud rate is set the application will detect it automatically.

6.3. Connecting to a Device (Device Discovery Window)

There are three tabs for the different type of interfaces: Ethernet, Serial, and USB.

The Ethernet tab consists of two lists:

- **Favorite devices:** You can add any Lightware device that is connected via Ethernet and no need to browse all the available devices.
- **All devices:** The Lightware devices are listed which are available in the network.

Further Tools

The Tools menu contains the following options:

- **Log viewer:** The tool can be used for reviewing previously saved log files.
- **Create EDID:** This tool opens the Easy EDID Creator wizard which can be used for creating unique EDIDs in a few simple steps. Functionality is the same as the Easy EDID Creator, for the detailed information see the [Creating an EDID](#) section.
- **Demo mode:** This is a virtual MX-FR17 matrix router with full functionality built into the LDC. Functions and options are the same as a real MX-FR17 device.

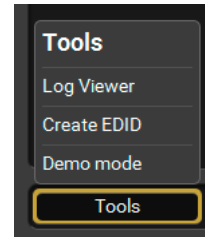

The Terminal window is also available by pressing its button on the bottom.

Establishing the Connection

Select the unit from the discovered Ethernet devices (see the picture on the right); if the device is connected via the RS-232 port click on the Query button next to the desired serial port to display the device's name and serial number (see the picture below). Double click on the device or select it and click on the green Connect button.

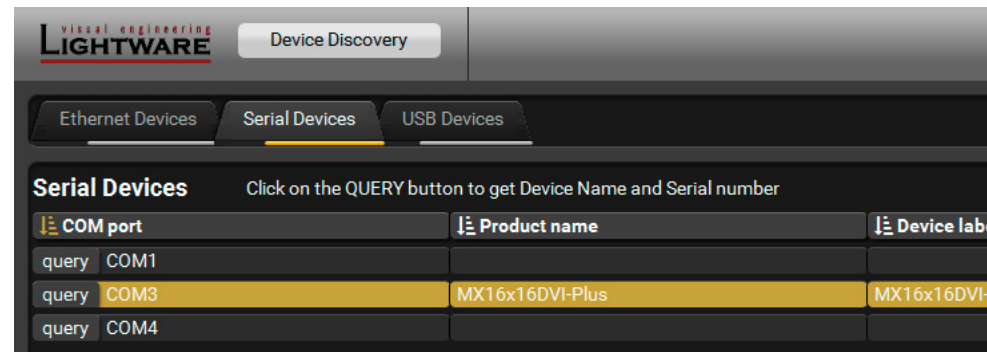

ATTENTION! When the device is connected via the local RS-232 port, make sure that LW protocol (#1) is set on the serial port. The protocol settings are available by the front panel buttons, see the [Control Protocols](#) section.

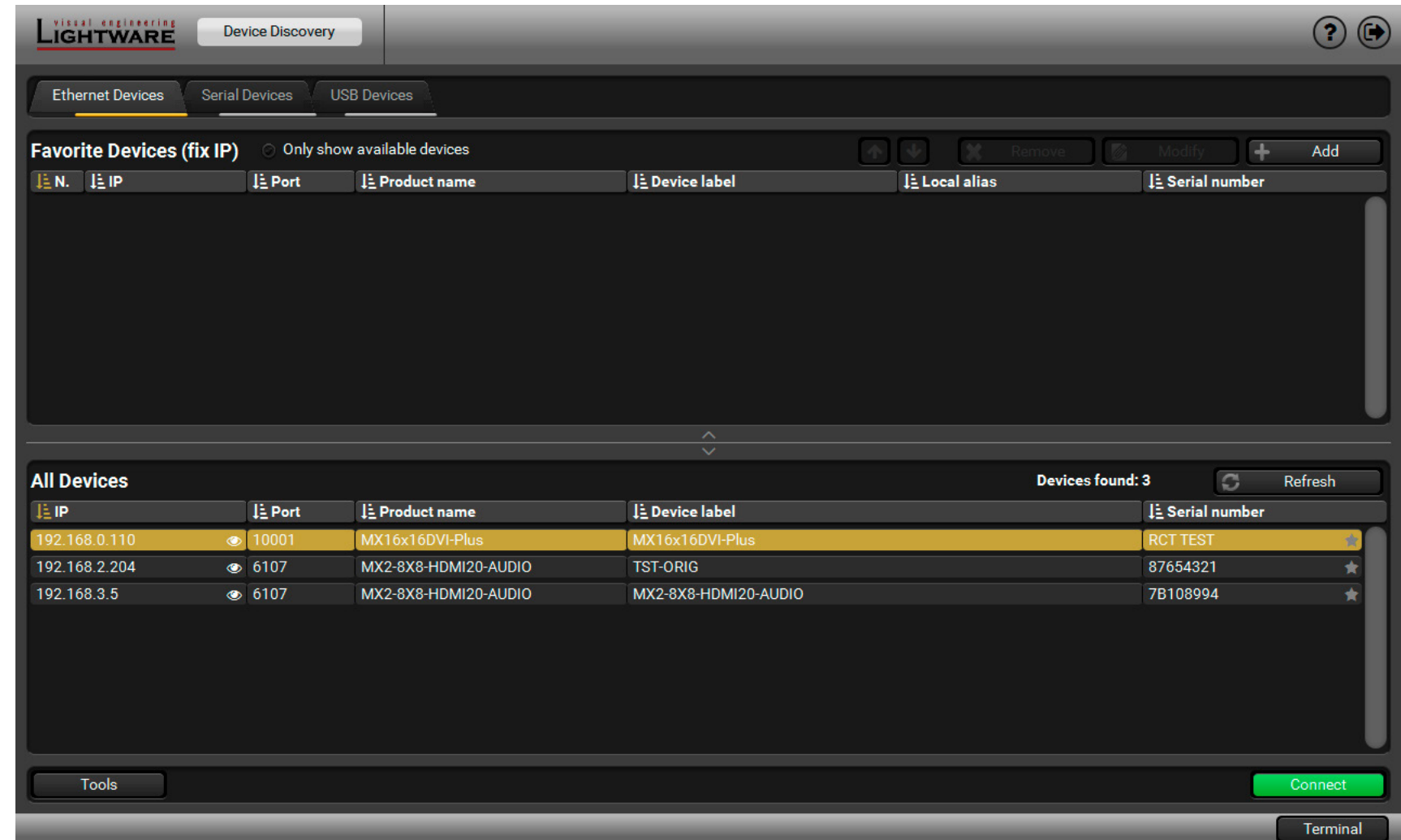

The Device Discovery Window

6.4. The Crosspoint Menu

6.4.1. Grid View

Grid view is a user-friendly graphical interface displaying the crosspoint state of the matrix router. This is an easy way to change between the input sources and output sinks.

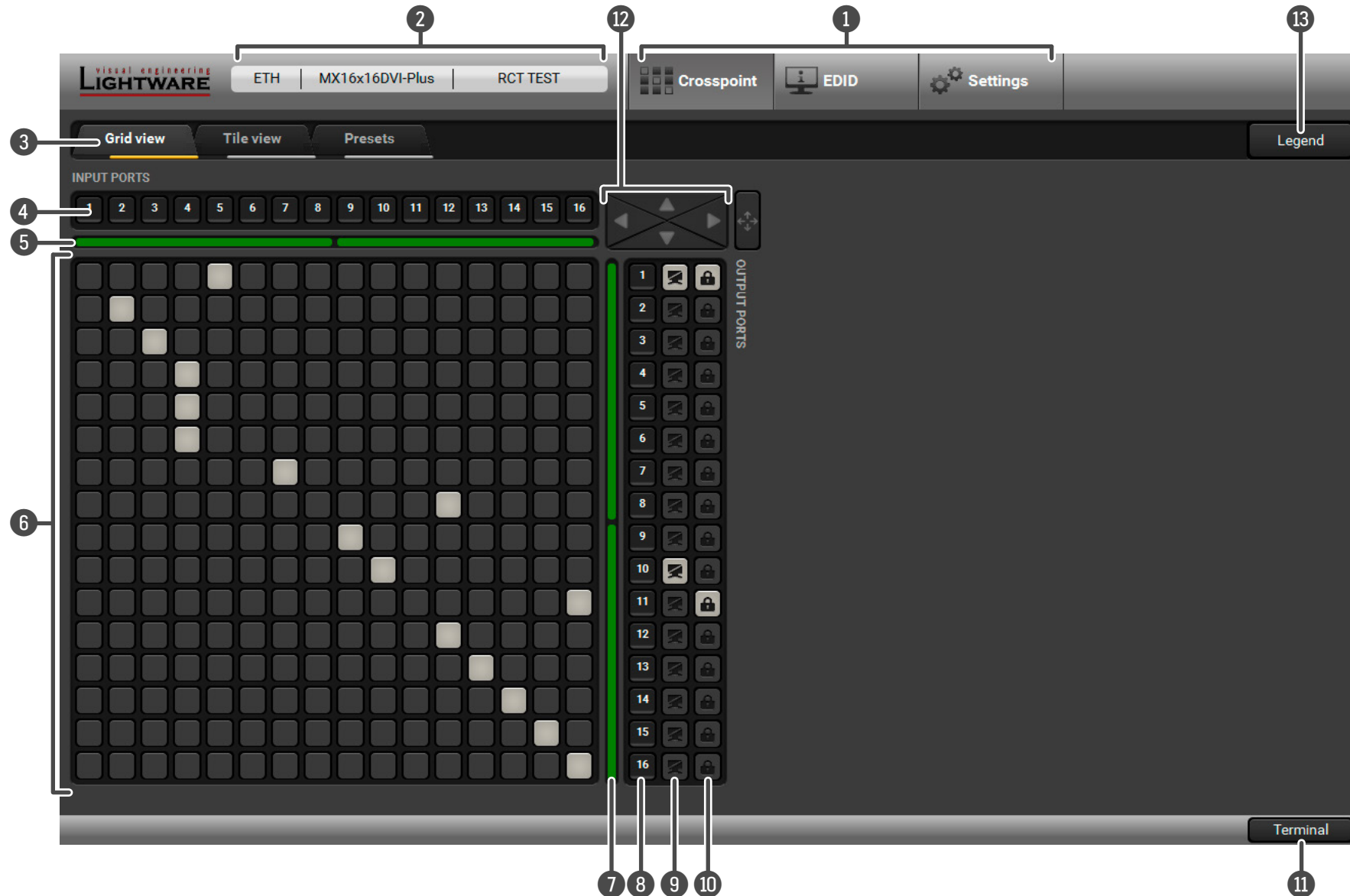

Grid View in the Crosspoint Menu

- 1 **Main Menu** The available menu items are displayed. The active one is highlighted with a dark grey background color.
- 2 **Information Ribbon** This label shows the interface type, the name and the serial number of the connected device. If the device has more than one interface, the ribbon shows only that one, which has made the connection. Click on the ribbon to open the device discovery window.
- 3 **Tab Selector Ribbon** The crosspoint and the settings menu contain more than one tab. Click on the desired one to select it. The yellow line shows which tab is the active one.
- 4 **Input Ports** Each number represents an input port. If the window size does not allow to display all the ports, pages can be turned by the left and right arrow buttons of the navigator.
- 5 **Input Boards** The color of the line shows what kind of input boards are installed (DVI).
- 6 **Connections** Dark grey square means the port is not available. Light grey square means the port is available but there is no connection. White square means there is a connection between the input and the output port.
- 7 **Output Boards** The color of the line shows what kind of output boards are installed (DVI).
- 8 **Output Ports** Each number represents an output port. If the window size does not allow to display all the ports, pages can be turned by the up and down arrow buttons of the navigator.
- 9 **Mute Buttons** Outputs can be easily muted by clicking on the mute button.
- 10 **Lock Buttons** For the prevention of the unwanted switching, outputs can be locked to any input.
- 11 **Terminal** This general-purpose terminal is created mainly for testing and debugging purposes. For more information see the [Terminal Window](#) section.
- 12 **Navigation Buttons** If the window size does not allow to display all the ports, pages can be turned by the arrow buttons of the navigator.
- 13 **Legend Button** Open the Legend panel displaying the meaning of the applied symbols and colors of the Grid view.

6.4.1.1. The Legend Window

The meaning of the symbols and applied colors in the Grid view are described in this window:

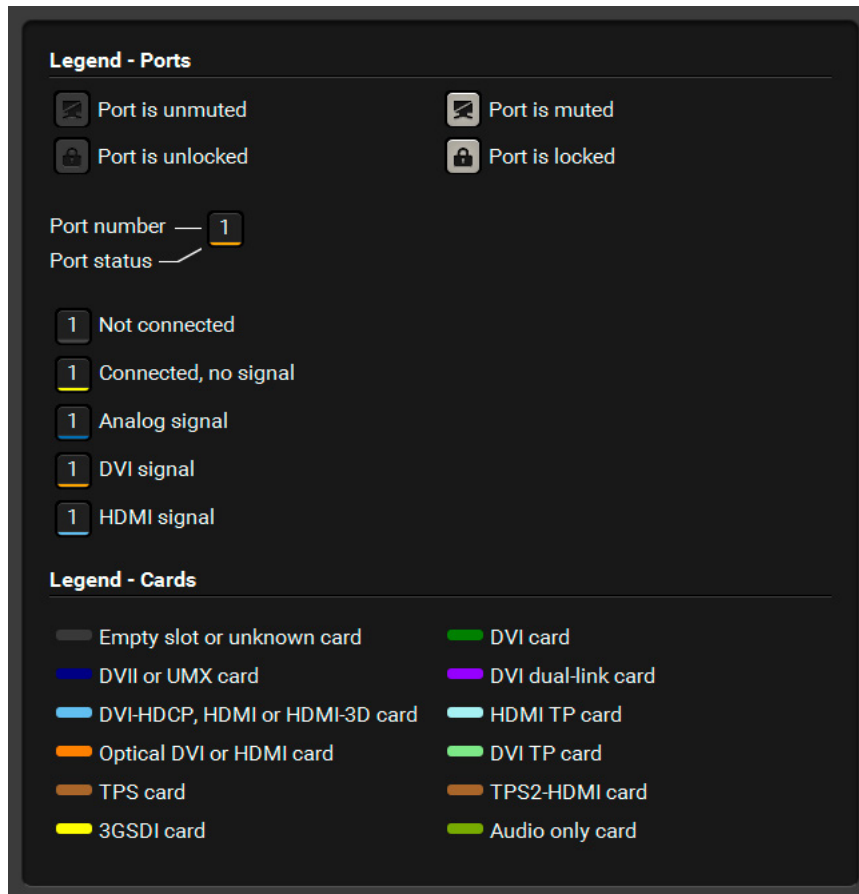

The Legend Window

6.4.1.2. Crosspoint Operations

Switching

For making a connection click on the desired square. If there is no connection between the desired input and output (the square is dark grey), the mouse pointer becomes a hand (link pointer) before the clicking. If the output port is not locked, the connection is made, the square becomes white and the cursor changes back to a pointer.



For example, input 16 is not connected to output 2 according to the first picture below. After the connection is established the square becomes light grey.

Muting the Outputs

Outputs can be easily muted by clicking on the button symbolized by a crossed monitor beside the output. This means that no signal is present at this output. If mute is active, the color of the button's background changes to white.

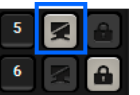

INFO: Inputs can be disconnected from any outputs (by protocol command). In this case, the crosspoint view will not show any white square for the disconnected output and the output will have no signal just like when muted. Click on a crosspoint square to connect the output again to an input.

Locking the Outputs

Outputs can be locked to any input. After locking an output to an input, no switching is permitted to this output unless it is unlocked again. If output lock is active, the color of the button's background changes to white.

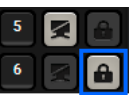

INFO: Loading a preset does not change either the lock state or the switch state of a locked output. If an output is locked to an input before preset loading it will also be locked to that input after preset loading, so locked outputs ignore the preset.

6.5. Tile View

The tile view is to display the input and output ports by tiles. Each tile means an input or output port and additionally shows the most important port and signal information. Thus, the user can check the status of many ports at the same time without clicking on a port or opening port settings window.

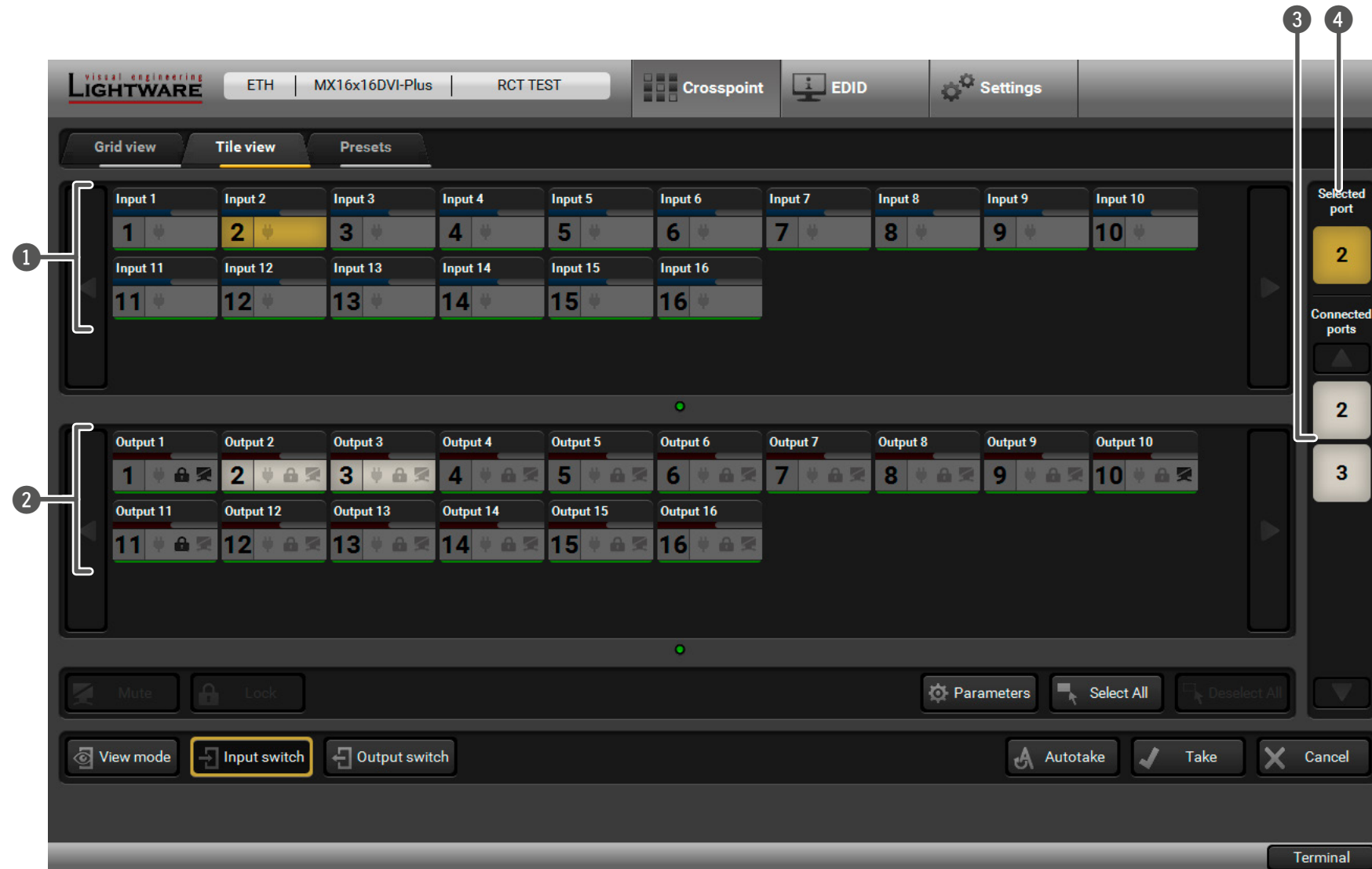









Tile View in the Crosspoint Menu

Legend

- 1 **Input Ports** Each tile represents an input port. If the window size does not allow to display all the ports, pages can be turned by the left and right arrow buttons.
- 2 **Output Ports** Each tile represents an output port. If window size does not allow to display all the ports, pages can be turned by the left and right arrow buttons.
- 3 **Connected Port(s)** Those ports are listed (with white background) on the port bar, which are connected to the Selected port.
- 4 **Selected Port** Last selected port is displayed with a yellow background on the port bar. Press the button to open the port settings window.

Control Buttons

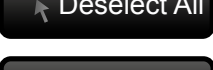
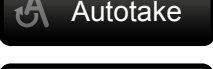
-  **Mute** Muting or unmuting the selected output port(s)
-  **Lock** Locking or unlocking the selected output port(s)
-  **View mode** Selecting the View mode
-  **Input switch** Selecting the Input switch mode
-  **Output switch** Selecting the Output switch mode
-  **Parameters** Displaying the port settings window
-  **Select All** Selecting all ports (only in output switch mode)
-  **Deselect All** Deselecting all ports (only in output switch mode)
-  **Autotake** Toggling the Autotake mode ON/OFF
-  **Take** Executing the crosspoint changes in Take mode

6.5.1. Port Tiles

The colors of the port tiles and the displayed icons represent different states and information:

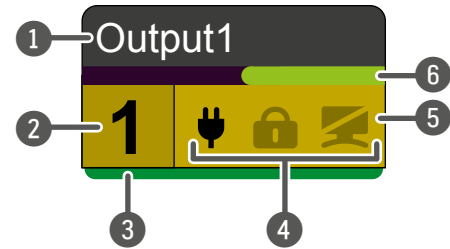

- 1 **Port name**
- 2 **Port number**
- 3 **Board type**
- 4 **State indicators**
- 5 **Background color**
- 6 **Signal present indicator**
green: present
grey: not present

Background Colors (Port State)

The colors of the port tiles represent different states of the port as follows:

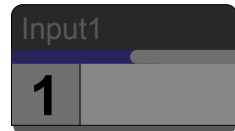

Dark grey
Port is not available
(no board is installed)



White
Connected port

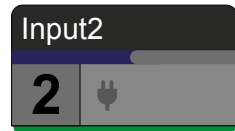

Light grey
Port is available

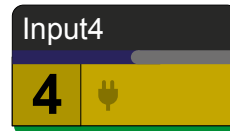

Yellow
Selected port

State Indicators

Icon	Icon is not displayed	Icon is grey	Icon is black
	No information is available about connection status	Port is available but inactive	Output ports: Port is available and sink is connected (hotplug detected) Input ports: Port is available and source is connected (power +5V detected)
	-	Port is unmuted	Port is muted
	-	Port is unlocked	Port is locked

Port Parameters

Select the desired port and press the **Parameters** button; a window pops up where the current port name can be set.

TIPS AND TRICKS: The parameters window can be also opened by selecting the desired port and click on its button on the port bar.

6.5.2. Display Modes

View Mode

The mode allows to display the current crosspoint-state. The crosspoint cannot be changed in this mode but port settings are available.



Input Switch Mode

The mode can also be named as 'Input priority-mode': an input port has to be selected at first then the connected output port(s) is/are shown. Thus, the output port(s) connected to the input port can be changed.



Output Switch Mode

This mode can also be named as 'Output priority-mode: an output port has to be selected at first then connected input port is shown. Thus, the output port connected to the input port can be changed. Output ports can be (un)locked, (un)muted only in Output switch mode.



6.5.3. Crosspoint Operations

Switching in Take Mode

The black outlined **Autotake** button means this mode is active. Any crosspoint change – (dis)connecting ports to/from the previously selected port – is executed only after pressing the **Take** button. Following steps describe the process of the switching:



- Step 1.** Press the desired **Input switch** or **Output switch** button to select switching mode.
- Step 2.** Select the desired **port**; it will be highlighted with yellow color and displayed on the port bar on the right, too.
- Step 3.** Connected port(s) is/are highlighted with white color and displayed on the port bar on the right, too.
- Step 4.** Create the desired **crosspoint settings** by (de)selecting the ports; they will start to blink.
- Step 5.** Press **Take** button to execute changes or **Cancel** to ignore the operations.

INFO: Take mode remains active until it is switched off. Selecting another view mode or menu does not change the Take/Autotake mode state.

Switching in Autotake Mode

The yellow outlined **Autotake** button means this mode is active. Any crosspoint change – (dis)connecting ports to/from the previously selected port – is executed immediately after pressing the port button. Following steps describe the process of the switching:



- Step 1.** Press the desired **Input switch** or **Output switch** button to select switching mode.
- Step 2.** Select the desired **port**; it will be highlighted and displayed on the port bar on the right, too.
- Step 3.** Connected ports are highlighted with white color and displayed on the port bar on the right, too.
- Step 4.** Create the desired crosspoint settings by (de)selecting the ports; the changes are executed immediately.

INFO: Autotake mode remains active until it is switched off. Selecting another view mode or menu does not change the Take/Autotake mode state.

6.5.4. Presets

Preset operations can be done in **Crosspoint** submenu on the **Preset tab**. Each Lightware matrix routers has 32 preset memories that can be loaded and saved at any time.

INFO: A preset setting stores a full configuration of all outputs. The preset loading has an effect on every output, except the locked ones.

Preset Preview

A preset can be selected by pressing its button on the left. The **Show preview on crosspoint** button will show the crosspoint of the input and output ports.

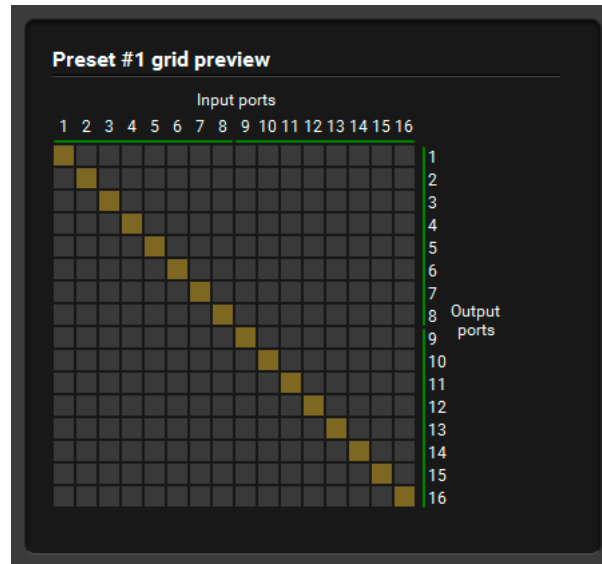

Loading a Preset

- Step 1.** Select the **Presets** tab from Crosspoint menu.
- Step 2.** Select the **preset memory** (Preset1... Preset32) you want to load.
- Step 3.** Press the **Load** button; the preset is loaded.
- Step 4.** The new I/O configuration is displayed in Grid view.

Saving a Preset

- Step 1.** Arrange the desired crosspoint connections.
- Step 2.** Select the **preset memory** (Preset1...Preset32) where you want to save your current crosspoint connections.
- Step 3.** Press **Save** button below Preset preview list.
- Step 4.** A confirmation message is displayed on the information bar; the preset is stored.

The Presets Tab

Renaming a Preset

- Step 1.** Select the **preset memory** (Preset1...Preset32) you want to rename.
- Step 2.** Type the desired name and press **Rename Preset** button; the new name is stored.

6.6. EDID Menu

The Advanced EDID Management is available in the EDID menu. There are two panels: left one contains Source EDIDs, right one contains Destination places where the EDIDs can be emulated or copied.

Sources and Destinations

- **Factory EDID** list shows the pre-programmed EDIDs (F1-F50).
- **Dynamic EDID** list shows the display device connected to the device's outputs. The unit stores the last display devices' EDID on either output, so there is an EDID shown even if there is no display device attached to the output port at the moment.
- **User memory** locations (U1 – U50) can be used to save custom EDIDs.
- **Emulated EDID** list shows the currently emulated EDID for the inputs. The source column displays the memory location that the current EDID was routed from.

The source reads the EDID from the Emulated EDID memory on the INPUT port. Any EDID from any of the User/Factory/Dynamic EDID lists can be copied to the user memory.

EDID Emulation Types

- **Static EDID emulation:** an EDID from the Factory or User EDID list is selected. Thus, the Emulated EDID remains the same until the user emulates another EDID.
- **Dynamic EDID emulation:** it can be enabled by selecting a slot from the Input 1..Input 16 EDID memory. The attached monitor's EDID is copied to the input; if a new monitor is attached to the output, the emulated EDID changes automatically.

Memory	Manuf.	Resolution	Monitor Name
U1	DEL	2560x1440@59.94Hz	Input_1
U2	DEL	2560x1440@59.94Hz	Input_2
U3	DEL	2560x1440@59.94Hz	Input_3
U4	DEL	2560x1440@59.94Hz	Input_4
U5	DEL	2560x1440@59.94Hz	Input_5
U6	DEL	2560x1440@59.94Hz	Input_6
U7	DEL	2560x1440@59.94Hz	Input_7
U8	DEL	2560x1440@59.94Hz	Input_8
U9	DEL	2560x1440@59.94Hz	Input_9
U10	DEL	2560x1440@59.94Hz	Input_10
U11	DEL	2560x1440@59.94Hz	Input_11
U12	DEL	2560x1440@59.94Hz	Input_12
U13	DEL	2560x1440@59.94Hz	Input_13
U14	DEL	2560x1440@59.94Hz	Input_14
U15	DEL	2560x1440@59.94Hz	Input_15
U16	DEL	2560x1440@59.94Hz	Input_16
U17	LWR	640x400@84.67Hz	640x400p85
U18	LWR	640x400@84.67Hz	640x400p85
U19			
U20	PHL	1920x1200@59.94Hz	Philips 230W5
U21	PHL	1920x1200@59.94Hz	Philips 230W5

EDID Inputs	Manuf.	Resolution	Monitor Name	Source
Input 1	DEL	2560x1440@59.94Hz	Input_1	U01
Input 2	DEL	2560x1440@59.94Hz	Input_2	U02
Input 3	DEL	2560x1440@59.94Hz	Input_3	U03
Input 4	DEL	2560x1440@59.94Hz	Input_4	U04
Input 5	DEL	2560x1440@59.94Hz	Input_5	U05
Input 6	DEL	2560x1440@59.94Hz	Input_6	U06
Input 7	DEL	2560x1440@59.94Hz	Input_7	U07
Input 8	DEL	2560x1440@59.94Hz	Input_8	U08
Input 9	DEL	2560x1440@59.94Hz	Input_9	U09
Input 10	DEL	2560x1440@59.94Hz	Input_10	U10
Input 11	DEL	2560x1440@59.94Hz	Input_11	U11
Input 12	DEL	2560x1440@59.94Hz	Input_12	U12
Input 13	DEL	2560x1440@59.94Hz	Input_13	U13
Input 14	DEL	2560x1440@59.94Hz	Input_14	U14
Input 15	DEL	2560x1440@59.94Hz	Input_15	U15
Input 16	DEL	2560x1440@59.94Hz	Input_16	U16

The EDID Menu



Exporting an EDID (save to a file)



Opening the Advanced EDID Editor with the selected EDID



Selecting all memory places in the right panel



Importing an EDID (load from a file)



Opening Easy EDID Creator



Selecting none of the memory places in the right panel



Displaying the EDID Summary window



Executing EDID emulation or copying (Transfer button)

6.6.1. EDID Operations

Changing the Emulated EDID

- Step 1.** Choose the desired **EDID list** (source panel) and select an EDID.
- Step 2.** Press the **Emulated** button on the top of the Destination panel.
- Step 3.** Select the desired **ports** on the right panel (one or more ports); the EDID(s) will be highlighted with a yellow cursor.
- Step 4.** Press the **Transfer** button to change the emulated EDID.

Learning an EDID

The process is the same as changing the emulated EDID; the only difference is the Destination panel: press the **User** button. Thus, one or more EDIDs can be copied into the user memory either from the factory memory or from a connected sink (Dynamic).

Exporting an EDID

ATTENTION! This function is working on Windows and Mac OS X operating systems and under Firefox or Chrome web browsers only.

Source EDID can be downloaded as a file (*.bin, *.dat or *.edid) to the computer.

- Step 1.** Select the desired **EDID** from the Source panel (the line will be highlighted with yellow).
- Step 2.** Press the **Save** button to open the dialog box and save the file to the computer.

Importing an EDID

Previously saved EDID (*.bin, *.dat or *.edid file) can be uploaded to the user memory:

- Step 1.** Press the **User** button on the top of the Source panel and select a memory slot.
- Step 2.** Press the **Upload** button below the Source panel.
- Step 3.** Browse the file in the opening window then press the **Open** button. Browsed EDID is imported into the selected User memory.

ATTENTION! The imported EDID overwrites the selected memory place even if it is not empty.

Deleting EDID(s)

The EDID(s) from User memory can be deleted as follows:

- Step 1.** Press **User** button on the top of the Destination panel.
- Step 2.** Select the desired **memory slot(s)**; one or more can be selected (Select All and Deselect All buttons can be used). The EDID(s) will be highlighted with yellow.
- Step 3.** Press the **Delete selected** button to delete the EDID(s).

6.6.2. EDID Summary Window

Select an EDID from Source panel and press **Info** button to display EDID summary window.

The screenshot shows the EDID Summary Window interface. On the left, there is a vertical list of EDID categories, with 'General' selected and highlighted in yellow. The categories include: General, Power Management, Gamma / Colors, Established Timings, Standard Timings, Preferred Timing Mode, 2nd Descriptor Field, 3rd Descriptor Field, 4th Descriptor Field, CEA General, CEA Video, CEA Audio, CEA Speaker Allocation, CEA HDMI VSDB, CEA HDMI Forum VSDB, CEA YCbCr 4:2:0 VDB, CEA YCbCr 4:2:0 Capability Map, CEA Colorimetry, CEA High Dynamic Range, and CEA Detailed Timing Descriptors. On the right, the 'General' summary is displayed with the following details:

EDID version:	1
EDID revision:	3
Manufacturer ID:	SAM (Samsung Electric Company)
Product ID:	8E09
Monitor serial number:	Not present
Year of manufacture:	2012
Week of manufacture:	9
Signal interface:	Digital
Separate Sync H&V:	-
Composite sync on H:	-
Sync on green:	-
Serration on VS:	-
Color depth:	Undefined
Interface standard:	Not defined
Color spaces:	RGB 4:4:4 & YCbCr 4:4:4
Aspect ratio:	0.56
Display size:	52 cm X 29 cm

The EDID Summary Window

6.6.3. Editing an EDID

Select an EDID from Source panel and press Edit button to display Advanced EDID Editor window. The editor can read and write all descriptors, which are defined in the standards, including the additional CEA extension. Any EDID from the device's memory or a saved EDID file can be loaded into the editor.

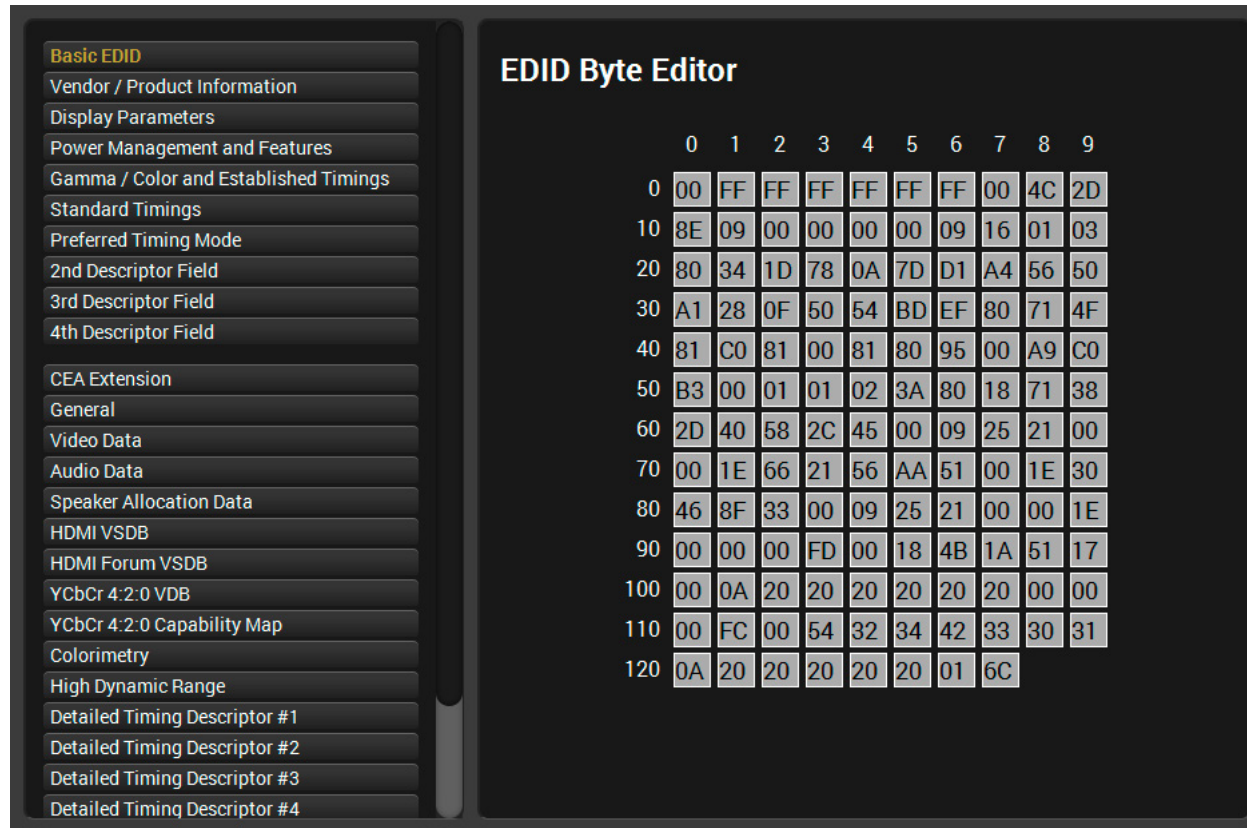

The EDID Editor Window

The software resolves the raw EDID and displays it as readable information to the user. All descriptors can be edited, and saved in an EDID file, or uploaded to the User memory. For more details about EDID Editor please visit our website (www.lightware.com) and download EDID Editor user's manual.

6.6.4. Creating an EDID

Since above mentioned Advanced EDID Editor needs more complex knowledge about EDID, Lightware introduced a wizard-like interface for fast and easy EDID creation. With Easy EDID Creator it is possible to create custom EDIDs in four simple steps.

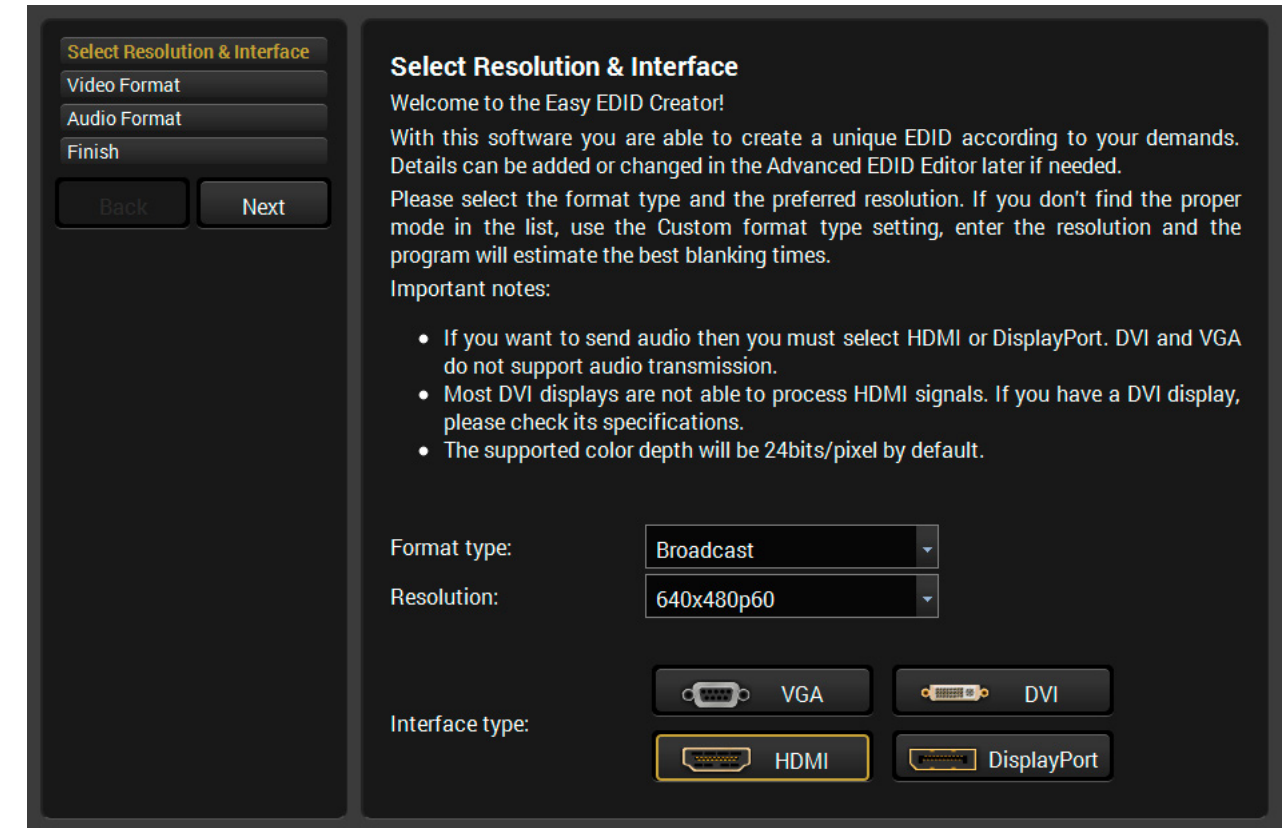

The Easy EDID Creator Window

By clicking on the **Create** button below Source panel, Easy EDID Creator is opened in a new window. For more details about EDID Editor please visit our website (www.lightware.com) and download EDID Editor user's manual.

6.7. Settings Menu

6.7.1. Configuration Tab

Settings about establishing the connection to the matrix are available on this tab.

IP Configuration

Getting the IP Address Automatically

The feature means that the matrix gets the IP address from the DHCP server on the LAN. If DHCP server is not present, the device gets an AutoIP address from 169.254.xxx.xxx domain automatically. Set BOOTP, DHCP and AutoIP settings according to your network requirements. Always press the **Apply settings** button to save changes.

INFO: Load default button restores the default network settings (fix IP) to the device: fix IP Address: 192.168.254.254, Subnet Mask: 255.255.0.0, Default Gateway: 0.0.0.0.

Static IP Configuration

In this case, connected device has an IP address configuration set up by the user/administrator. Depending on modified settings, you might need to restart the device and the Control Software. Always press the **Apply settings** button to save changes.

INFO: Load default button restores the default network settings (fix IP) to the device: fix IP Address: 192.168.254.254, Subnet Mask: 255.255.0.0, Default Gateway: 0.0.0.0.

TCP Port Configuration

Devices can be accessed via this TCP/IP port number with TCP connection. Port number can be modified to any number between 1025 and 65535 except the followings:

- 9999, 14000 - 14009, 30704, and 30718.
- To use a matrix with Barco Encore set the port to 23.
- To use a matrix with Vista Spyder set the port to 10001.

Always press the **Apply settings** button to save changes.

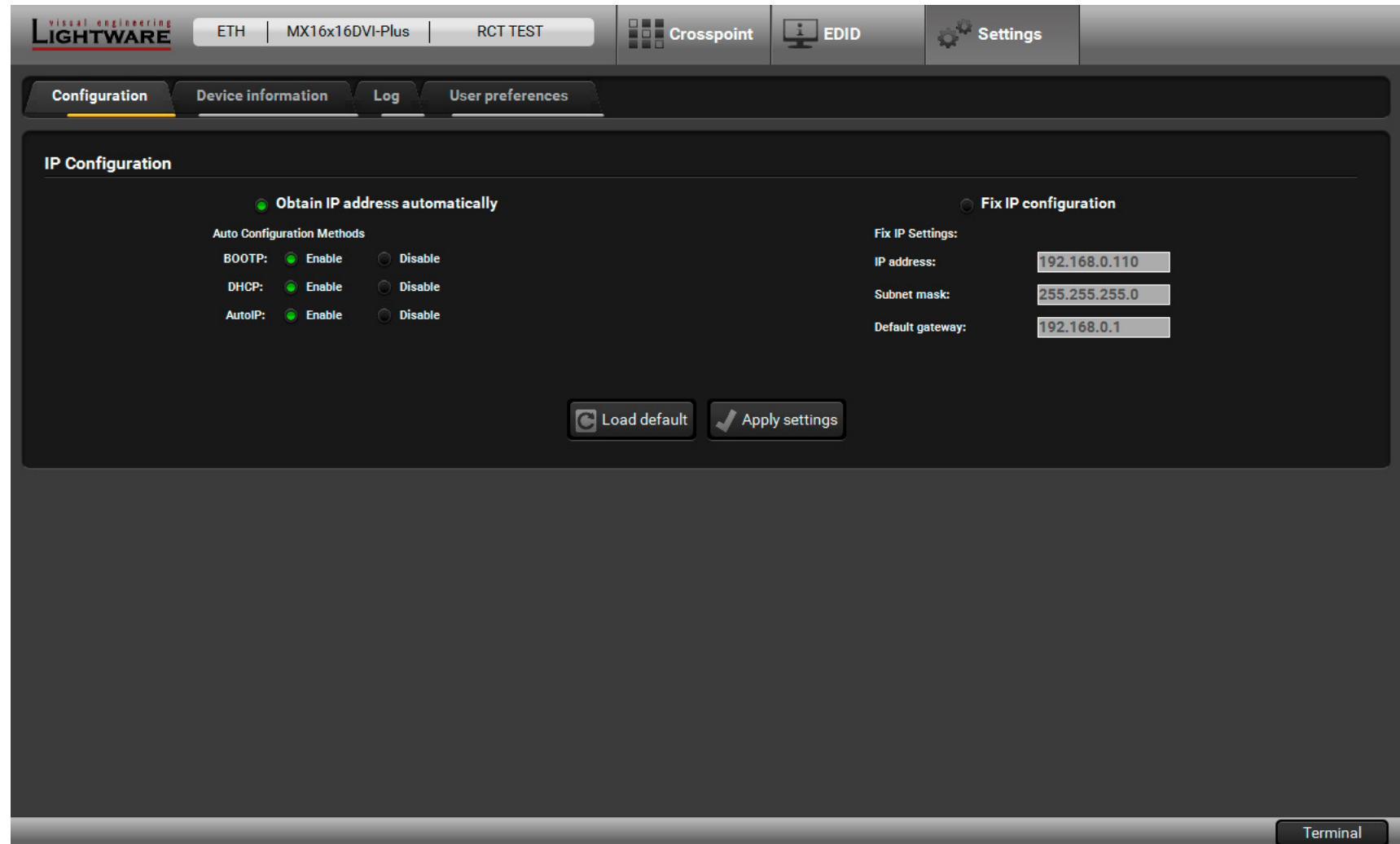

The Configuration Tab

6.7.2. Device Information Tab

Basic information is displayed about the device in this menu: Device type with serial number and the type of the installed boards with firmware and hardware version.

6.7.3. Log Tab

Generating a Standard Report File

LDC is able to collect information from the device and save it to a report file. This information package can be sent to Lightware when a problem may arise with the device.

ATTENTION! When a report is necessary to generate, always let the devices be connected to the device, do not disconnect them. The Controller Software will collect information about the devices and about their status.

Step 1. Press the **Generate report** button on the **Log** tab in the **Settings** menu:

Step 2. The **Save as** dialog box appears. Select the place where you want to save the report file. The default file name can be changed.

Step 3. LDC collects the needed information. This may take up to 5 minutes.

Step 4. When the process is finished, the folder is opened, where the file was saved. The report contains the following information:

- The current command protocol,
- The equipment type and serial number,
- Status of input/output ports,
- Installed controllers and I/O board types and firmware with versions,
- Network settings,
- All EDID headers and status (emulated, dynamic, factory, user).

Generating a Custom Report File

The Controller Software is able to send a custom command file to the device. The command file can be generated by Lightware support. This is needed when some special commands have to be used for configuring or troubleshooting.

This function is only for special troubleshooting cases.

The screenshot shows the 'Device Information' tab selected in the software interface. The top navigation bar includes 'ETH', 'MX16x16DVI-Plus', 'RCT TEST', 'Crosspoint', 'EDID', and 'Settings'. Below the navigation bar, the 'Device Information' section displays the following details:

Device:	MX16x16DVI-Plus
Serial Number:	RCT TEST
MAC address:	00-20-4A-E3-1F-93

Below this, the 'Installed Cards' section displays a table with the following data:

Slot Name	Card Name	Firmware Version	Hardware Version	Serial number
CPU Card	Web Content	FW:1.4.1		
CPU Card	Web Server	FW:1.1.5		
CPU Card	MX-CPU	FW:2.5.0		
MOTHERBOARD	MX16X16DVI-PLUS		SCH_2.5 PCB_2.5	
SLOT 1	MX16X16DVI-PLUS-OB		SCH_2.5 PCB_2.5	
SLOT 2	MX16X16DVI-PLUS-OB		SCH_2.5 PCB_2.5	
SLOT 3	MX16X16DVI-PLUS-IB		SCH_2.5 PCB_2.5	
SLOT 4	MX16X16DVI-PLUS-IB		SCH_2.5 PCB_2.5	
Control Panel	MX-CP	FW:1.0.8		
CPU Card	MX-DVI-EDID	FW:3.3.4		

The Device Information Tab

The screenshot shows the 'Log' tab selected in the software interface. The top navigation bar is identical to the previous screenshot. Below the navigation bar, the 'Log' section displays a 'Report' area with two buttons:

- Download report** (a red button)
- Generate report from file** (a button with a file icon)

The Log Tab

6.7.4. User Preferences

The tab shows some settings in connection with the LDC displaying/working mode.

These settings are saved by the LDC and applied next time when the software is started (independently from the type of the matrix). The size of the LDC window is also restored from the last run.

6.8. Terminal Window

This general purpose terminal is intended mainly for testing and debugging purposes. When a successful connection is established with a router this terminal can be used either via serial RS-232, TCP/IP LAN or USB connection. All commands can be used here that are discussed in the programmer's reference. The command text can be typed directly.

By default commands are automatically surrounded by framing brackets. Every sent command and every received response gets an arrow (-> or <-) prefix, and has different font colors in order to help to distinguish.

The timecode in every row shows the exact time when the command was sent or the response received.

If the **Command framing** checkbox is unchecked, you can send multiple commands together, however in this case you have to type in the framing brackets manually.

The terminal can be also opened after starting the LDC - press the Terminal button on the Device discovery page on the bottom of the window.

TIPS AND TRICKS: The typed commands can be 'browsed' when the cursor is in the command line and you press the up button on the keyboard. The commands are stored until the LDC is closed.

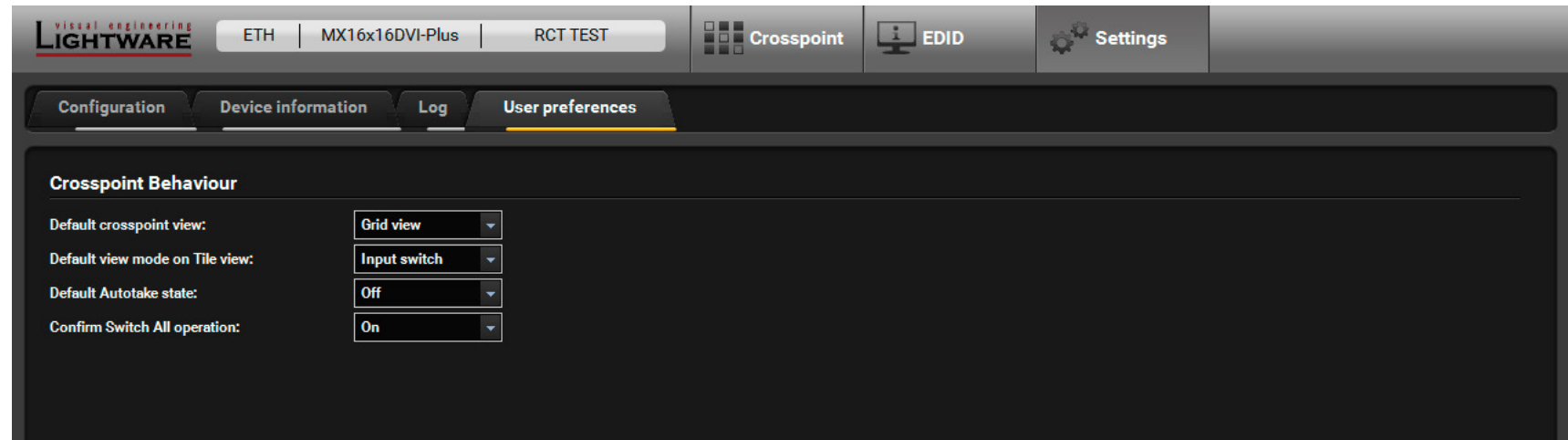

The User Preferences Tab

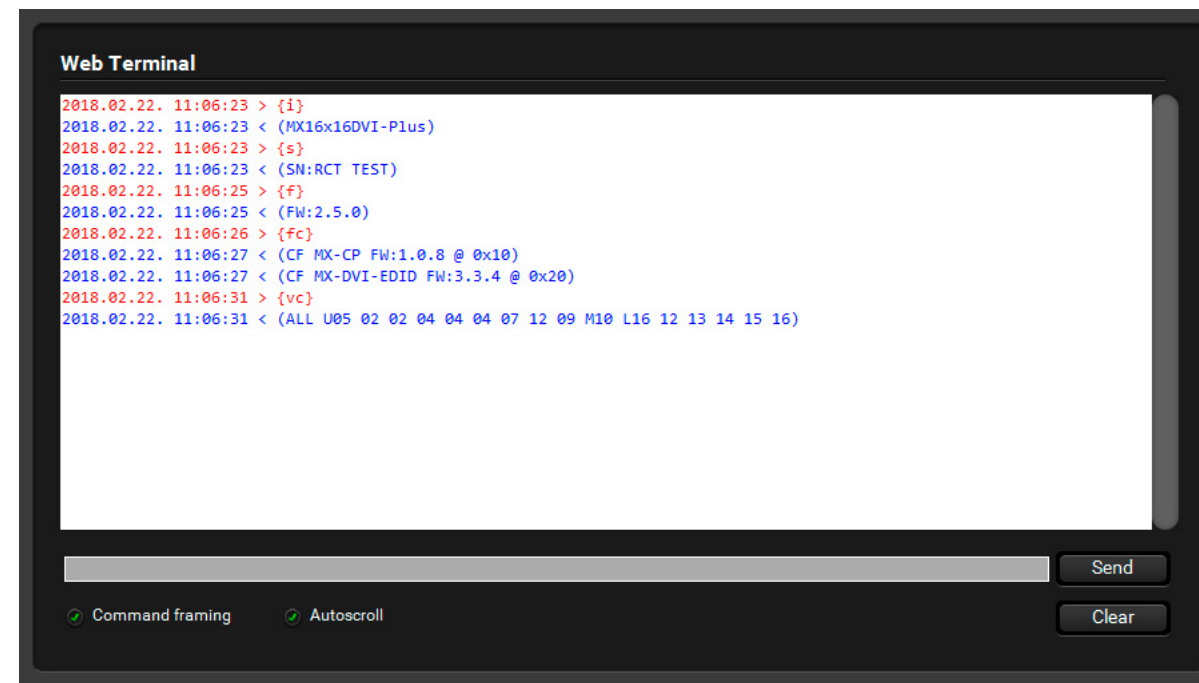

The Terminal Window

7

Programmers' Reference

The user can connect to the matrix through Ethernet or serial port. After establishing the connection, there is no difference between connection types (except some rare cases, which are uniquely noted). Lightware matrix routers can be controlled with external devices which can communicate according to the router protocol. Lightware routers have a special protocol, but to interoperate with third-party devices, a secondary protocol is also provided. The supported LW2 commands are described in this chapter:

- ▶ [PROTOCOL DESCRIPTION](#)
- ▶ [SWITCHING AND CONTROL COMMANDS](#)
- ▶ [PORT/PRESET NAMING](#)
- ▶ [COMMUNICATION SETUP COMMANDS](#)
- ▶ [PORT STATUS COMMANDS](#)
- ▶ [ROUTER STATUS COMMANDS](#)
- ▶ [EDID ROUTER COMMANDS](#)
- ▶ [ROUTER INITIATED COMMANDS](#)
- ▶ [COMMANDS – QUICK SUMMARY](#)

7.1. Protocol Description

The protocol description hereinafter stands for the Lightware protocol.

The matrix routers accept commands surrounded by curly brackets - { } - and responds data surrounded by round brackets - () - only if a command was successfully executed. The input command is converted to uppercase but the response may contain upper and lower case letters as well.

Legend for control commands:

Format	Explanation
<in>	Input number in 1 or 2 digit ASCII format (01, 5, 07, 16, etc.)
<out>	Output number in 1 or 2 digit ASCII format
<in ² >	Input number in 2 digit ASCII format (01, 02, 10, 12 etc.)
<out ² >	Output number in 2 digit ASCII format (01, 02, 10, 12 etc.)
<loc>	Location number in 1, 2 or 3 digit ASCII format
<id>	id number in 1 or 2 digit ASCII format
<id ² >	id number in 2 digit ASCII format
CrLf	Carriage return, Line feed (0x0D, 0x0A)
•	Space character (0x20)
→	Each command issued by the controller
←	Each response received from the router

Changing Protocols

The matrix is equipped with multiple protocols. The currently used protocol can be viewed or changed any time on the matrix front panel (see the [Control Protocols](#) section) or by protocol commands (see the [Querying the Current Protocol](#) section).

Batch Commands

Usually the commands are sent one by one to the matrix, but this is not a must. Any command can be sent to the matrix in a batch. To do this, just use the same commands (including { } brackets), but put the 'CrLf' only at the end of the batch.

In most cases, batch commands are processed just as if they were sent one by one, but for switching commands, the matrix groups them, and executes switching in one step. The grouping is done only if the switching commands are received after each other, without any interruption (e.g. other command sent between switch commands). In this case, the response format changes, as not only one output's state changed. The response will be in the format as if {VC} were sent.

Below example shows a command that resulted batch switching:

One by one Commands	Batch Commands
→ {02@01}	→ {02@01}{05@04}
← (001 I02)CrLf	← (001 I02)CrLf
→ {05@04}	← (004 I05)CrLf
← (004 I05)CrLf	

The below example shows a command that did not result batch switching because another command has been inserted:

One by one Commands	Batch Commands
→ {02@01}	→ {02@01}{+06}{05@04}
← (001 I02)CrLf	← (001 I02)CrLf
→ {+06}	← (0MT06)CrLf
← (0MT06)CrLf	← (004 I05)CrLf
→ {05@04}	
← (004 I05)CrLf	

7.2. Switching and Control Commands

7.2.1. Switching an Input to an Output

Description: Switch input <in> to output <out>.

Format	Example
Command {<in>@<out>}	→ {1@5}
Response (O<out>●I<in>)CrLf	← (005 I01)CrLf

Explanation 1: Input 1 is switched to output 5.

7.2.2. Switching an Input to All Outputs

Description: Switch input <in> to all outputs.

Format	Example
Command {<in>@0}	→ {02@0}
Response (I<in>●ALL)CrLf	← (I02 ALL)CrLf

Explanation: Input 2 is switched to all outputs.

ATTENTION: The response for this command does not show if any of the outputs are muted. To check the mute status a separate query has to be used.

ATTENTION: The response for this command does not show if there were some locked outputs which cannot be switched.

7.2.3. Querying the I/O Connections

Description: Viewing all outputs' connection results in different response length, because it depends on the number of I/O ports. The response below supposes a matrix having 17 outputs.

Format	Example 1
Command {VC}	→ {vc}
Response (ALL●<01>●<02>●<03>●<04>●<05>●<06>●<07> ●<08>●<09>●<010> ●<011>●<0121>●<013>●<014>●<015>●<016>)CrLf	← (ALL 02 02 02 05 05 05 08 08 08 08 08 08 08 08 08 08)CrLf

Legend 1: All <0x> indexes show the corresponding output's connection state. If value <05> equals 04 it means that output 5 is connected to input 4. All <0x> indexes are two digit ASCII characters (01, 02, 04, etc.).

Explanation 1: Viewing connection for all outputs. Input 2 is connected to outputs 1, 2 and 3. Input 5 is connected to outputs 4, 5 and 6. Input 8 is connected to outputs 7 through 16.

ATTENTION! If an output is locked, muted, or both locked and muted, the response format changes. If outputs are muted you get a letter 'M', if locked a letter 'L' and if muted and locked at the same time 'U' before the 2 digit numbers.

Format	Example 2
Command {VC}	→ {vc}
Response (ALL●<01>●<02>●<03>●<04>●<05>●<06>●<07> ●<08>●<09>●<010>●<011>●<0121>●<013> <014>●<015>●<016>)CrLf	← (ALL M02 L02 U02 05 05 05 08 08 08 08 08 08 08 08 08)CrLf

Legend 2: Any <0x> indexes can be a two digit number, or there can be a leading character showing the mute and/or lock state for the corresponding output.

Index	Legend	Explanation
<0x>	<in ² >	<0x> is connected to <in ² >, <0x> neither muted nor locked.
<0x>	M<in ² >	<0x> is connected to <in ² >, <0x> is muted, and unlocked.
<0x>	L<in ² >	<0x> is connected to <in ² >, <0x> is not muted, but locked.
<0x>	U<in ² >	<0x> is connected to <in ² >, <0x> is muted and locked.

Explanation 2: Viewing connection for all outputs. Input 2 is connected to outputs 1, 2 and 3. Output 1 is muted. Output 2 is locked. Output 3 is muted and locked. Input 5 is connected to outputs 4, 5 and 6. Input 8 is connected to outputs 7 through 16.

7.2.4. Resetting the Outputs

Description: Reloading the factory default output setup.

Format	Example
Command {r00}	→ {roo}
Response (APWSE)CrLf	← (APWSE)CrLf

7.2.5. Querying the Mute States

Description: Viewing all outputs' mute state results in different response length, depending on the number of the I/O ports.

Format	Example
Command {VM}	→ {vm}
Response (MUT●<M1>●<M2>●<M3>●<M4>●<M5>● <M6>●<M7> ●<M8>●<M9>●<M10>●<M11>● <M12>●<M13> ●<M14>●<M15>●<M16>)CrLf	← (MUT 1 0 1 1 0 0 0 0 0 0 0 0 0 0 0)CrLf

Legend: All <Mx> indexes are one digit numbers, showing the mute state for the corresponding output. If <Mx> equals 0 the output x is unmuted. If <Mx> equals 1, the output x is muted.

Explanation: Output 1, 3 and 4 are muted, the other outputs are not muted.

7.2.6. Muting an Output

Description: Mute output <out>. The output signal is turned off.

Format	Example
Command {#<out>}	→ {#03}
Response (1MT<out²>)CrLf	← (1MT03)CrLf

Explanation: Output 3 is muted. No signal is present on output 3 now.

ATTENTION! Muting does not change the crosspoint's state but disables the output itself. This way the last connection can be easily restored with an unmute command.

ATTENTION! Switching a muted output does not unmute the output.

7.2.7. Unmuting an Output

Description: Unmute output <out>.

Format	Example
Command {+<out>}	→ {+03}
Response (0MT<out²>)CrLf	← (0MT03)CrLf

Explanation: Output 3 is unmuted. Now output 3 is switched to the input it was connected to prior to the mute command.

ATTENTION! Unmuting an output makes the previous connection active as the crosspoint's state has not been changed with the muting command, only the output was disabled.

7.2.8. Locking an Output

Description: Lock output <out>. Output's state cannot be changed until unlocking.

Format	Example
Command {#><out>}	→ {#>05}
Response (1LO<out²>)CrLf	← (1LO05)CrLf

Explanation: Output 5 is locked.

7.2.9. Unlocking an Output

Description: Unlock output <out>. The connection on output can be changed.

Format	Example
Command {+<<out>}	→ {+<05}
Response (0LO<out²>)CrLf	← (0LO05)CrLf

Explanation: Output 5 is unlocked.

INFO: The matrix issues the above response regardless of the previous state of the output (either it was locked or unlocked).

7.2.10. Saving a Preset

Description: Save current crosspoint configuration (output states) to preset <id>.

Format	Example
Command {\$<id>}	→ {\$4}
Response (SPR<id²>)CrLf	← (SPR04)CrLf

Explanation: Current crosspoint state is saved to preset 4, including the mute state of the outputs. All frames have 32 preset memories.

ATTENTION! Lock states are not saved. Lock state is assigned to the physical output of the matrix. Presets do not affect output locks.

7.2.11. Loading a Preset

Description: Load crosspoint configuration from preset <id>.

Format	Example
Command {%<id>}	→ {%4}
Response (LPR<id²>)CrLf	← (LPR04)CrLf

Explanation: Current crosspoint state is changed according to preset 4, including the mute state of the outputs.

INFO: Presets do not affect locked outputs.

7.2.12. Preset Preview

Description: Preview stored connections in preset <id> without loading it. The length of the response depends on the crosspoint size.

Format	Example
Command {VP#<id>=?}	→ {vp#3=?}
Response (VP#<id>=●<O1>●<O2>●<O3>●<O4>●<O5>●<O6> ●<O7>●<O8>●<O9>●<O10>●<O11>●<O121>●<O13>●<O14>●<O15>●<O16>)CrLf	← (VP#3= 02 M02 M01 02 02 01 01 01 01 01 01 01 01 01)CrLf

Legend:

Index	Legend	Explanation
<Ox>	<in ² >	<Ox> is connected to <in ² >, <Ox> is not muted.
<Ox>	M<in ² >	<Ox> is connected to <in ² >, <Ox> is muted.

Explanation: Viewing connections for preset 3. Input 2 is connected to outputs 1, 2, 4 and 5. Input 1 is connected to all other outputs. Outputs 2 and 3 are muted.

7.3. Port/Preset Naming

7.3.1. Querying a Preset Name

Format	Example
Command {PNAME#<id>=?}	→ {pname#1=?}
Response (PNAME#<id>= <preset_name>)CrLf	← (PNAME#1=First_preset)CrLf

Explanation: Name for preset 1 is 'First_preset'.

7.3.2. Renaming a Preset

Format	Example
Command {PNAME#<id>= <preset_name>}	→ {pname#1=First preset}
Response (PNAME#<id>= <preset_name>)CrLf	← (PNAME#1=First preset)CrLf

Explanation: Preset 1 was named as 'First preset'.

7.3.3. Querying an Input Name

Format	Example
Command {INAME#<in>=?}	→ {iname#1=?}
Response (INAME#<in>= <Input_name>)CrLf	← (INAME#1=PC_1)CrLf

Explanation: Name for input 1 is 'PC_1'.

7.3.4. Renaming an Input

Format	Example
Command {INAME#<in>=<input_name>}	→ {iname#3=Media_Player}
Response (INAME#<in>=<input_name>)CrLf	← (INAME#3=Media_Player)CrLf

Explanation: Input 3 was named as 'Media_Player'.

7.3.5. Querying an Output Name

Format	Example
Command {ONAME#<out>=?}	→ {oname#2=?}
Response (ONAME#<out>= <output_name>)CrLf	← (ONAME#2=Monitor_2)CrLf

Explanation: Name for output 1 is 'Monitor_2'.

7.3.6. Renaming an Output

Format	Example
Command {ONAME#<out>= <output_name>}	→ {oname#2=Monitor#2}
Response (ONAME#<out>= <output_name>)CrLf	← (ONAME#2=Monitor#2)CrLf

Explanation: Output 2 was named as 'monitor#2'.

7.3.7. Default Preset Names

ATTENTION! The <id> field is not relevant here, only has to be a valid one. The command will affect ALL presets disregarding the actual number that was in the command.

Format	Example
Command {PNAME#<id>=!}	→ {pname#2=!}
Response (PNAME#<id>= Preset●<id>)CrLf	← (PNAME#2=Preset 2)CrLf

Explanation: All preset names are set to default: 'Preset 1', 'Preset 2', and so on.

7.3.8. Default Input Names

ATTENTION! The <id> field is not relevant here, only has to be a valid one. The command will affect ALL inputs disregarding the actual number that was in the command.

Format	Example
Command {INAME#<id>=!}	→ {iname#4=!}
Response (INAME#<id>= Input●<id>)CrLf	← (INAME#4=Input 4)CrLf

Explanation: All input names are set to default: 'Input 1', 'Input 2', and so on.

7.3.9. Default Output Names

ATTENTION! The <id> field is not relevant here, only has to be a valid one. The command will affect ALL outputs disregarding the actual number that was in the command

Format	Example
Command {ONAME#<id>=!}	→ {oname#3=!}
Response (ONAME#<id>= Output<id>)CrLf	← (ONAME#3=Output 3)CrLf

Explanation: All output names are set to default: 'Output 1', 'Output 2', and so on.

7.4. Communication Setup Commands

7.4.1. Querying the IP Settings

Description: The TCP/IP settings can be queried from the matrix by this command.

Format	Example
Command {IP_CONFIG=?}	→ {ip_config=?}
Response (IP_CONFIG=<id> ●<ip_address>●<port> ●<mask>●<gateway>)CrLf	← (IP_CONFIG=0 192.168.2.106 10001 255.255.0.0 192.168.0.0)CrLf

Legend:

Identifier	Description	Default value
<id>	0: fix IP 7: DHCP	0
<ip_address>	IP address	192.168.254.254
<port>	TCP/IP port	10001
<mask>	subnet mask	255.255.0.0
<gateway>	gateway address	0.0.0.0

Explanation: The matrix has a static IP address 192.168.2.106 on the 255.255.0.0 subnet with a gateway on 192.168.2.1 and communicates over TCP port 10001.

7.4.2. Reloading the Default IP Settings

Format	Example
Command {IP_CONFIG=!}	→ {ip_config=!}
Response (Changing●IP● configuration...)CrLf (DONE!)CrLf or (FAILED!)CrLf	← (Changing IP configuration...)CrLf ← (DONE!)CrLf

The default parameters are reloaded, see the **Legend** above.

ATTENTION! IP settings can NOT be changed by this protocol command via Ethernet connection, only via serial port. To change the IP settings via Ethernet use the built-in website ([Loading the Default IP Settings](#) section) or the Lightware Device Controller software ([Configuration Tab](#) section). The default settings can be reloaded by the front panel buttons as well ([IP Settings](#) section).

7.4.3. Setting a Dynamic IP Address

Description: After issuing this command via the serial connection the matrix will inquire dynamic IP address (DHCP).

Format	Example
Command {IP_CONFIG=D}	→ {ip_config=D}
Response (Changing●IP● configuration...)CrLf (DONE!)CrLf or (FAILED!)CrLf	← (Changing IP configuration...)CrLf ← (DONE!)CrLf

Parameters after successful command execution:

Parameter	Value
IP address	Acquired with DHCP
port number	unchanged
Subnet mask	unchanged
Gateway	unchanged

ATTENTION! IP settings can NOT be changed by this protocol command via Ethernet connection, only via serial port. To change the IP settings via Ethernet use the built-in website ([Loading the Default IP Settings](#) section) or the Lightware Device Controller software ([Configuration Tab](#) section). The default settings can be reloaded by the front panel buttons as well ([IP Settings](#) section).

7.4.4. Network Components

Description: This command shows information about the LAN interface.

Format	Example
Command {LAN_VER=?}	→ {lan_ver=?}
Response (MAC_ADDR=<mac>)CrLf (WEB_VER=<web>)CrLf (SERVER_VER)=<ser>CrLf	← (MAC_ADDR=00-20-4A-E3-1D-E42)CrLf (WEB_VER=1.4.1)CrLf (SERVER_VER=1.1.5)CrLf

Legend:

Parameter	Value
<mac>	the MAC address
<web>	the version of the built-in web (webcontent)
<ser>	the version of the LAN controller firmware (webserver)

7.5. Port Status Commands

7.5.1. Input Port Status

Description: Shows the actual status of the input ports. The response length depends on the number of the input ports.

Format	Example
Command {:ISD}	→ {:isd}
Response (ISD●<INPUT_D>)CrLf	← (ISD 10000000 1001000 10000000 00000000)CrLf

Explanation: Input 1, 9, 12 and 16 has a connected source.

Legend: <INPUT_D> always contains 32 decimal numbers but the first 16,12 or 9 are valid only. (It depends on the matrix size). Each number represents the state for the corresponding input port:

- 0: There is no connected source or does not send 5V,
- 1: The connected source is connected and sends 5V.

7.5.2. Output Port Status

Description: Shows the actual status of the output ports. The response length depends on the number of the output ports.

Format	Example
Command {:OSD}	→ {:osd}
Response (OSD●<OUTPUT_D>)CrLf	← (OSD 01000000 1011000 00000000 00000000)CrLf

Explanation: There are four DVI sinks connected to ports 2, 9, 11 and 12, nothing else.

Legend: <OUTPUT_D> always contains 32 decimal numbers but the first 16,12 or 9 are valid only. Each number represents the state for the corresponding output port.

- 0: There is no connected DVI sink or does not send Hotplug signal,
- 1: Hotplug signal is presented by the connected device.

7.6. Router Status Commands

7.6.1. Querying the Product Type

Description: The response contains the type of the device.

Format	Example
Command {I}	→ {i}
Response (<PRODUCT_TYPE>)CrLf	← (I: MX16x16DVI-Plus)CrLf

Explanation: The connected device is an MX16x16DVI-Plus matrix.

7.6.2. Querying the Serial Number

Description: The device responds its 8-digit serial number.

Format	Example
Command {S}	→ {s}
Response (SN:<SERIAL_N>)CrLf	← (SN:3C019935)CrLf

Explanation: The connected device's serial number is 3C019935.

7.6.3. Querying the CPU FW version

Description: View the CPU firmware revision. To view other controller's firmware version see the {FC} command.

Format	Example
Command {F}	→ {f}
Response (FW:<FW_VER>)CrLf	← (FW:2.5.0)CrLf

Explanation: The firmware version of the CPU is 2.5.0.

7.6.4. Querying the CPU FW Compile Time

Description: Shows the CPU firmware compile time.

Format	Example
Command {CT}	→ {ct}
Response (Compiled:●<DATE>●<TIME>●Build:●<tag>)CrLf	← (Compiled: Aug 29 2012 17:39:36, build: 1624)CrLf

Legend:

Parameter	Value
<DATE>	Month, day and Year
<TIME>	Hours, minutes and seconds
<tag>	Identification number of the firmware

Explanation: The firmware was made on 29.08.2012, 17:39:36 and the identification number of the firmware is 1624.

7.6.5. Installed I/O Boards

Description: Shows the hardware name and revision of the installed boards.

INFO: This matrix model is a compact type, so there are no separate input/output boards. The Empty Slot descriptors are listed only because of compatibility issues.

Format	Example
Command {IS}	→ {is}
Response (SL#0●<MB_DESC>)CrLf	← (SL# 0 MX16X16DVI-PLUS SCH_2.5 PCB_2.5)CrLf
(SL#1●<OB_DESC>)CrLf	← (SL# 1 MX16X16DVI-PLUS-OB SCH_2.5 PCB_2.5)CrLf
(SL#2●<OB_DESC>)CrLf	← (SL# 2 MX16X16DVI-PLUS-OB SCH_2.5 PCB_2.5)CrLf
(SL#3●<OB_DESC>)CrLf	← (SL# 3 Empty Slot)CrLf
(SL#4●<OB_DESC>)CrLf	← (SL# 4 Empty Slot)CrLf
(SL#5●<IB_DESC>)CrLf	← (SL# 5 MX16X16DVI-PLUS-IB SCH_2.5 PCB_2.5)CrLf
(SL#6●<IB_DESC>)CrLf	← (SL# 6 MX16X16DVI-PLUS-IB SCH_2.5 PCB_2.5)CrLf
(SL#7●<IB_DESC>)CrLf	← (SL# 7 Empty Slot)CrLf
(SL#8●<IB_DESC>)CrLf	← (SL# 8 Empty Slot)CrLf

Explanation: The matrix reports two output- and two input boards.

7.6.6. Querying the Controllers' Firmware

Description: The device responds its 8-digit serial number.

Format	Example
Command {FC}	→ {fc}
Response (<FIRMWARE_LIST>)CrLf	← (CF MX-CP FW: 1.0.8 @ 0x10)CrLf (CF MX-DVI-EDID FW: 3.2.3 @ 0x50)CrLf

Explanation: The response shows the firmware of the Control panel and the EDID controller.

7.6.7. Querying the Current Protocol

Description: Shows the currently active RS-232 and TCP/IP control protocol.

Format	Example
Command {P_?}	→ {p_?}
Response (CURRENT●PROTOCOL● =●#<x>)CrLf	← (CURRENT PROTOCOL = #1)CrLf

Explanation: <x> stands for the active protocol.

Legend:

The value of <x>	Description
1	Lightware protocol (default)
2	P#2 protocol

7.6.8. Setting the Current Protocol

Description: Sets the current RS-232, TCP/IP control protocol.

Format	Example
Command {P_<x>}	→ {p_1}
Response (PROTOCOL●#<x>● SELECTED!)CrLf	← (PROTOCOL #1 SELECTED!)CrLf

Explanation: Protocol #1 is activated. See the legend in the previous section.

7.6.9. Viewing the Error List

Description: Shows the error list since the last boot.

Format	Example
Command {ELIST=?}	→ {elist=?}
Response (<class>,<e_desc><e_code>,<e_occ>)CrLf	← (0,BOOT,00,1)CrLf
...	...
(<class>,<e_desc><e_code>,<e_occ>)CrLf	← (0,BOOT,08,2)CrLf

Legend:

INFO: The error list can contain NOTICES and WARNINGS under normal operation. These entries do not mean that there is any problem with the matrix.

Parameter	Description
<class>	Class of the error
<e_desc>	Short description of the error
<e_code>	Short device address in HEX format
<e_occ>	The occurrence number of this type of error entry

7.6.10. Clearing the Error List

Description: Clearing the whole error list.

Explanation: All error entries have been cleared.

Format	Example
Command {ELIST=!}	→ {elist=!}
Response (List●is●empty!)CrLf	← (List is empty!)CrLf

7.7. EDID Router Commands

The EDID router manipulates the EDID memory, which has memory locations assigned to specific input or output ports. Please see [The EDID Memory of a Matrix](#) section about the EDID memory structure.

7.7.1. Static EDID Emulation

Description: Copies EDID from location <loc> to input <in>. <loc> must be 1..100.

Format	Example
Command {<in>:<loc>}	→ {5:10}
Response (E_SW_OK)CrLf ...delay... (E_S_C)CrLf	← (E_SW_OK)CrLf ... delay ... ← (E_S_C)CrLf

INFO: The router sends (E_S_C) only if the new EDID is different from the earlier one.

Explanation: EDID from memory location 10 is copied to input 5.

7.7.2. Dynamic EDID Emulation

Description: Copies EDID from location <loc> to input <in>. Location <loc> should be 101...116 (MX16x16DVI-Plus) or 101...112 (MX12x12DVI-Plus) or 101...109 (MX9x9DVI-Plus) as opposed to static routing where <loc> should be between 1..100.

Explanation: EDID from output 2 is copied to input 4.

Format	Example
Command {<in>:<loc>}	→ {4:102}
Response (E_SW_OK)CrLf ...delay... (E_S_C)CrLf	← (E_SW_OK)CrLf ... delay ... ← (E_S_C)CrLf

After choosing a dynamic EDID routing to one (or all) inputs the router will follow the EDID changes occurring on the output it was connected to. Every time a different EDID is recognized.

INFO: Outputs 1..16 are mapped to logical addresses 101..116.

7.7.3. Routing an EDID to All Inputs

Description: Copies EDID from the selected location <loc> to all inputs. Location <loc> should be between 1..100 for static routing and between 101..116 for dynamic routing.

Explanation: EDID from memory location 48 is copied to all inputs.

Format	Example
Command {A:<loc>}	→ {a:48}
Response (E_SW_OK)CrLf ...delay... (E_S_C)CrLf	← (E_SW_OK)CrLf ... delay ... ← (E_S_C)CrLf

INFO: This operation takes about 10 seconds.

7.7.4. Querying the Emulated EDIDs

Description: Indexes show the actual input and the number at the given index (<in1>..<inN>) shows which EDID is switched to that particular input where N represents the maximal input number of the given configuration.

Legend: Any <INx> indexes are three digit numbers showing the current EDID that is routed to the corresponding input. Respond length depends on input number of the router.

Format	Example
Command {VEDID}	→ {vedid}
Response (VEDID●<IN1>●<IN2>●<IN3>●<IN4>● <IN5>●<IN6>●<IN7>●<IN8>●<IN9>● <IN10>●<IN11>●<IN12>●<IN13>● <IN14>●<IN15>●<IN16>)CrLf	← (VEDID 048 048 053 101 101 101 101 101 101 101 101 101 101 101 101 101)CrLf

Explanation: Factory preset EDID from memory location 48 is emulated on inputs 1 and 2. User saved EDID from memory location 53 is emulated on input 3. EDID from output 1 is dynamically emulated on all other inputs.

7.7.5. Saving an EDID (Learning)

Description: Learn EDID from the specified output <out> to the specified location <loc>. Memory locations 51..100 are available for saving learned EDIDs.

Format	Example
Command {<out>><loc>}	→ {4>51}
Response (E_SW_OK)CrLf (E_S_C)CrLf	← (E_SW_OK)CrLf ← (E_S_C)CrLf

Explanation: EDID from output 4 is saved to EDID memory location 51.

7.7.6. Viewing the EDID Header

Description: Querying the header of an EDID.

Format	Example
Command {WH<loc>}	→ {wh104}
Response (EH#<loc>●<PNPID>●<res>●<name>) CrLf	← (EH#104 NEC 1280x1024@60LCD1970NXp) CrLf

Legend:

Parameter	Description
<PNPID>	The three letter abbreviation of the manufacturer
<res>	The resolution and the refresh rate (preferred)
<name>	The name of the display device stored in the product descriptor.

Explanation: Shows the EDID from memory location 104

7.7.10. Deleting All EDID from Memory

Description: Clearing all User, Emulated, and Last attached Monitor's EDID.

Format	Example
Command <code>{:CLREDID}</code>	<code>→ {:clredid}</code>
Response <code>(E_S_C)CrLf</code>	<code>← (E_S_C)CrLf</code>

Explanation: All EDIDs are cleared except the factory EDIDs.

7.8. Router Initiated Commands

7.8.1. Restarting the CPU

Description: The CPU controller can be restarted without unplugging power.

Format	Example
Command <code>{RST}</code>	<code>→ {rst}</code>
Response <code>(CPU_RESET...)CrLf(<name>•Ready!)CrLf</code>	<code>← (CPU_RESET...)CrLf(MX16x16DVI-Plus Ready!)CrLf</code>

Legend: <name> is the type of the matrix.

Explanation: The matrix reboots and sends a message when it is ready.

INFO: The response can be seen only if the connection to the matrix is still alive.

7.8.2. Restarting the EDID Controller

Description: The CPU controller can be restarted without unplugging power.

Format	Example
Command <code>{:RST}</code>	<code>→ {:rst}</code>
Response <code>(Booting...)CrLf</code>	<code>← (Booting...)CrLf</code>
<code>(BOOT•SLOT•1•STARTED)CrLf</code>	<code>← (BOOT SLOT 1 STARTED)CrLf</code>
<code>(SL#•1•<OB_DESC>)CrLf</code>	<code>← (SL# 1 MX16x16DVI-PLUS-OB SCH_2.5 PCB_2.5)CrLf</code>
<code>(SL#•1•<OB_DESC>)CrLf</code>	<code>← (SL# 1 MX16x16DVI-PLUS-OB SCH_2.5 PCB_2.5)CrLf</code>
<code>(BOOT•SLOT•1•FINISHED)CrLf</code>	<code>← (BOOT SLOT 1 FINISHED)CrLf</code>
<code>⋮</code>	<code>⋮</code>
<code>(BOOT•SLOT•8•STARTED)CrLf</code>	<code>← (BOOT SLOT 8 STARTED)CrLf</code>
<code>(BOOT•SLOT•8•FINISHED)CrLf</code>	<code>← (BOOT SLOT 8 FINISHED)CrLf</code>

Legend: (MX16x16DVI-Plus): The matrix reports that all input and output boards have been restarted.

INFO: The response can be seen only if the connection to the matrix is still alive.

7.8.3. EDID Status Changed

Description: This response is sent after the commands which change the EDID (EDID copy, EDID switch), or after a new EDID source e.g. a new display device is connected to the matrix.).

Format	Example
Command <i>various</i>	<code>→ {5:101}</code>
Response <code>(E_S_C)CrLf</code>	<code>← (E_SW_OK)CrLf</code>
	<code>← (E_S_C)CrLf</code>

Explanation: Copy EDID from output 1 to input 5 (dynamic emulation). The first response confirms the EDID routing command. The `(E_S_C)` response is an automatic message that is sent because of an EDID change.

To keep your application in sync with the matrix it is recommended to issue a show validity (`{wv}`) command after receiving an EDID status changed response, and read all location indicating '3' in the table, as the change of these EDID triggered the EDID status changed response.

INFO: The router stores the last attached display device's EDID connected to the output. After disconnecting this device its EDID is still present at the router's memory, therefore no status change message is issued by the router if a display device having the same EDID is connected to that output. (The same display device is connected again, or another display device (same brand) from the same manufacturer).

7.8.4. Error Responses

Error Type	Description	Response
Invalid Input Number	Given input number exceeds the maximum number of inputs or equals zero.	<code>(ERR01)CrLf</code>
Invalid Output Number	Given output number exceeds the installed number of outputs or equals zero.	<code>(ERR02)CrLf</code>
Invalid Value	Given value exceeds the maximum allowed value can be sent.	<code>(ERR03)CrLf</code>
Invalid Preset Number	Given preset number exceeds the maximum allowed preset number.	<code>(ERR04)CrLf</code>

INFO: The maximum preset number is limited to 32 for all matrix routers.

7.9. Commands – Quick Summary

Switching and Control Commands

Operation	See in Section	Command
Switching an Input to an Output	7.2.1	{<in>@<out>}
Switching an Input to All Outputs	7.2.2	{<in>@0}
Querying the I/O Connections	7.2.3	{VC}
Resetting the Outputs	7.2.4	{r00}
Querying the Mute States	7.2.5	{VM}
Muting an Output	7.2.6	{#<out>}
Unmuting an Output	7.2.7	{+<out>}
Locking an Output	7.2.8	{#><out>}
Unlocking an Output	7.2.9	{+><out>}
Saving a Preset	7.2.10	{\$<id>}
Loading a Preset	7.2.11	{%<id>}
Preset Preview	7.2.12	{VP#<id>=?}

Port/Preset Naming

Operation	See in Section	Command
Querying a Preset Name	7.3.1	{PNAME#<id>=?}
Renaming a Preset	7.3.2	{PNAME#<id>=<preset_name>}
Querying an Input Name	7.3.3	{INAME#<id>=<input_name>}
Renaming an Input	7.3.4	{ONAME#<id>=<output_name>}
Querying an Output Name	7.3.5	{INAME#<id>=?}
Renaming an Output	7.3.6	{ONAME#<id>=?}
Default Preset Names	7.3.7	{PNAME#<id>=!}
Default Input Names	7.3.8	{INAME#<id>=!}
Default Output Names	7.3.9	{ONAME#<id>=!}

Communication Setup Commands

Operation	See in Section	Command
Querying the IP Settings	7.4.1	{IP_CONFIG=?}
Reloading the Default IP Settings	7.4.2	{IP_CONFIG=!}
Setting a Dynamic IP Address	7.4.3	{IP_CONFIG=D}
Network Components	7.4.4	{LAN_VER=?}

Port Status Commands

Operation	See in Section	Command
Input Port Status	7.5.1	{:ISD}
Output Port Status	7.5.2	{:OSD}

Router Status Commands

Operation	See in Section	Command
Querying the Product Type	7.6.1	{i}
Querying the Serial Number	7.6.2	{S}
Querying the CPU FW version	7.6.3	{F}
Querying the CPU FW Compile Time	7.6.4	{CT}
Installed I/O Boards	7.6.5	{IS}
Querying the Controllers' Firmware	7.6.6	{FC}
Querying the Current Protocol	7.6.7	{P_?}
Setting the Current Protocol	7.6.8	{P_1}
Viewing the Error List	7.6.9	{ELIST=?}
Clearing the Error List	7.6.10	{ELIST=!}

EDID Router Commands

Operation	See in Section	Command
Static EDID Emulation	7.7.1	{<in>:<loc>}
Dynamic EDID Emulation	7.7.2	{<in>:<loc>}
Routing an EDID to All Inputs	7.7.3	{A:<loc>}
Querying the Emulated EDIDs	7.7.4	{VEDID}
Saving an EDID (Learning)	7.7.5	{<out>><loc>}
Viewing the EDID Header	7.7.6	{WV}
Querying the EDID Validity Table	7.7.7	{WH<loc>}
Downloading the Content of an EDID	7.7.8	{WE<loc>}
Uploading the Content of an EDID	7.7.9	{WL#<loc>}
Deleting All EDID from Memory	7.7.10	{:CLREDID}

Router Initiated Commands

Operation	See in Section	Command
Restarting the CPU	7.8.1	{RST}
Restarting the EDID Controller	7.8.2	{:RST}
EDID Status Changed	7.8.3	(E_S_C)
Error Responses	7.8.4	(ERR01)-(ERR04)

8

Firmware Upgrade

The controllers of the matrix can be upgraded by using the Lightware Bootloader software. The steps and some useful tips about the process are described in this chapter. To get the latest software and firmware pack please contact support@lightware.com.

- ▶ [SHORT INSTRUCTIONS](#)
- ▶ [DETAILED INSTRUCTIONS](#)
- ▶ [IF THE UPGRADE IS UNSUCCESSFUL](#)

8.1. Short Instructions

- Step 1.** Get the **Lightware Bootloader** Software and the firmware files.
- Step 2.** Install the application and prepare the firmware files.
- Step 3.** Connect the computer to the matrix via LAN and launch the Bootloader.
- Step 4.** Find the device and establish the connection.
- Step 5.** Select the desired controllers.
- Step 6.** Perform the firmware upgrade.
- Step 7.** Finish and restart the matrix.

8.2. Detailed Instructions

Step 1: Get the Lightware Bootloader Software and the Firmware Files

Use the Lightware Bootloader application to upgrade the firmware(s) of the matrix. Please contact support@lightware.com to get the latest application and the firmware files.

Step 2: Install the Application and Prepare the Firmware Files

Run the Bootloader installer; installing the application to the default destination is recommended. If you got the firmware files, extract them to a folder on the computer.

Step 3: Connect the Computer to the Matrix via LAN and Launch the Bootloader

TIPS AND TRICKS: To avoid packet loss caused by an overloaded network, it is recommended to use the supplied cross UTP cable directly from the upgrading PC to the matrix.

If the computer is connected via a network hub, switch, or router, you can set the matrix to have a static IP address or a dynamic IP address.

- **Static IP address:** in this case, make sure there is no IP conflict on the network.
- **Dynamic IP address:** in this case, the matrix has got an IP address automatically if a DHCP server is in the network.

TIPS AND TRICKS: If you do not know the IP address of the matrix, close the bootloader and launch the Lightware Device Controller software. The desired device and its IP address must be listed in the Device Discovery window if a proper connection has been established.

The static/dynamic IP settings can be done by the front panel buttons, please see the [IP Settings](#) section.

Run the **Lightware Bootloader** software.

Step 4: Find the Device and Establish the Connection

Make sure that no other active connection is established to the matrix (running the Lightware Device Controller software or a web browser and the built-in website). Please wait until all the devices on the network completely start up, then click on the **Find** button to query the Ethernet; the discovered devices are listed.

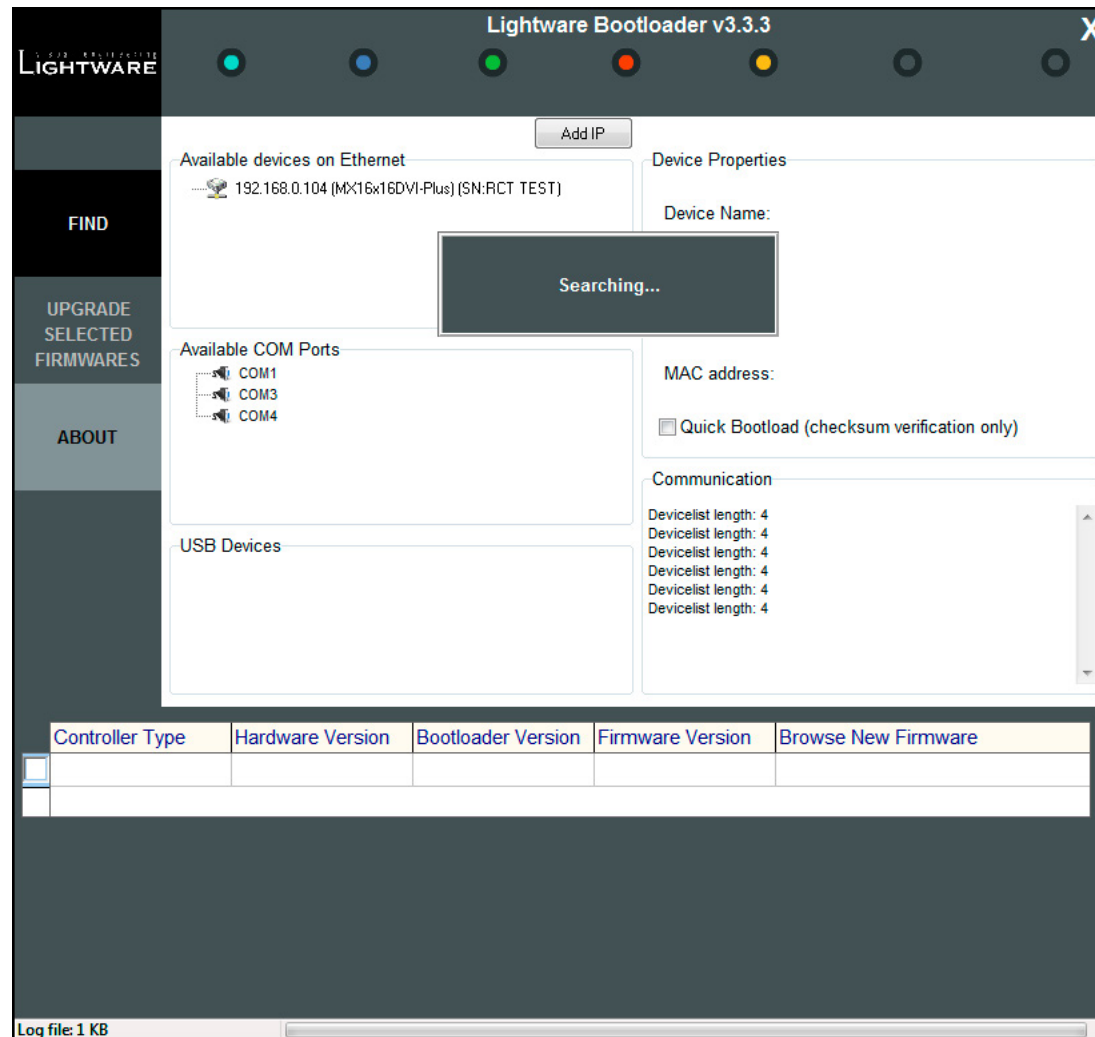

Lightware Bootloader – Searching for Devices

If the desired device is not discovered for some reason but you know its IP address you can add it manually. Press the **Add IP** button and fill the text boxes. Double click on the **IP address**, then click **Yes** to establish the connection. It will take 10-15 seconds to load all the information.

IP Address:	<input type="text"/>	<input type="button" value="Add"/>	<input type="button" value="Cancel"/>
<input type="checkbox"/> Use the following TCP Port:			
Port:	<input type="text"/>		

ATTENTION! The bootloader application will restart the matrix when it establishes the connection. All connected DVI sources and monitors will act as if the matrix was powered down. The matrix beeps when it is rebooted.

Step 5: Select the Desired Controllers

After the connection is made, the device properties and the installed controller modules are displayed.

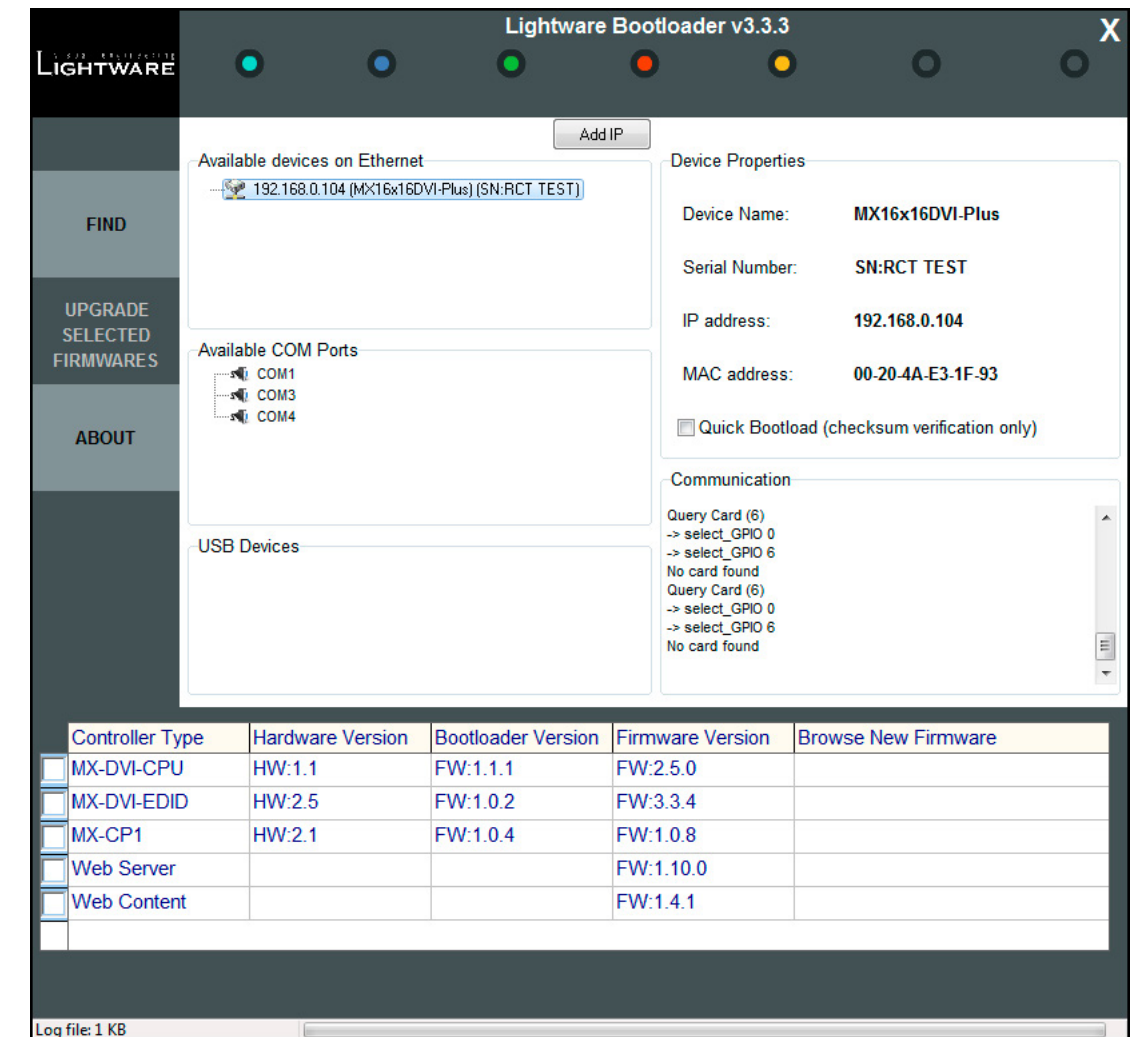

Lightware Bootloader – Details of the Device

Select the desired controllers by clicking the checkboxes.

Controller Type	Hardware Version	Bootloader Version	Firmware Version	Browse New Firmware
<input type="checkbox"/> MX-DVI-CPU	HW:1.1	FW:1.1.1	FW:2.5.0	
<input checked="" type="checkbox"/> MX-DVI-EDID	HW:2.5	FW:1.0.2	FW:3.3.4	MX-CPU1_EDID_SLIM_v3.3.4.hex
<input type="checkbox"/> MX-CP1	HW:2.1	FW:1.0.4	FW:1.0.8	
<input checked="" type="checkbox"/> Web Server			FW:1.10.0	WEBSERVER_MX-CPU1_v1.1.6.ro
<input type="checkbox"/> Web Content			FW:1.4.1	

Load the new firmware files for each controller; click on the cell in the Browse New Firmware column of the desired controller (see the pointer on above picture). A dialog pops up to confirm if you really want to load a new firmware (modify the path). Now you can browse the new firmware file. After opening the new file, the cell will contain the name of the firmware file.

Step 6: Perform the Firmware Upgrade

Press the **Upgrade selected firmwares** button; a confirmation message appears. After clicking the **Yes** button the selected controllers are being reprogrammed by the firmware you selected. If you selected a file that does not belong to the given controller you will get a message. If you selected a controller to upgrade but you had not set a firmware file to it then you will also get a message.

Quick Bootload mode can be switched on or off at any time. It makes the bootloader software faster by only checking the checksum of the controller. No data verification is done after writing if the checksum was correct.

ATTENTION! The reprogramming can take between 3-8 minutes per controller.

A progress bar will show the current state of the reprogramming on the bottom of the main window. In certain cases, the firmware of the given controller is erased which is also shown by the progress bar, thus, the progress bar runs up twice.



Step 7: Finish and Restart the Matrix

When the reprogramming is finished, a message will appear in the bottom left corner (**Done!**). If the upgrade was successful, the following window pops up.

The device is disconnected from the application automatically and the matrix is restarted. Now you can close the application, or you can select another matrix router to upgrade. After closing the bootloader application, switch the upgraded devices off and then on. Now the matrix is ready to be used with the new firmware.

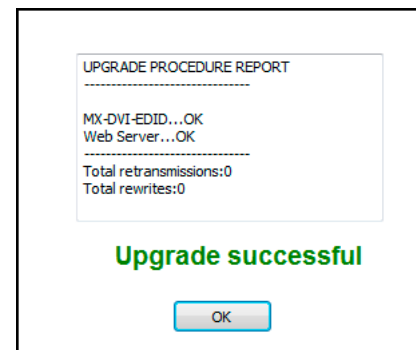

8.3. If the Upgrade is Unsuccessful

'Upgrade failed'

If the connection is unreliable and the Bootloader cannot communicate with the Lightware device, then the **Upgrade failed!** warning message appears. The Bootloader retries the transmission three times. If it does not succeed the upgrade procedure will have failed. In that case, close the Bootloader application and try to establish a reliable connection to the Lightware device and repeat the upgrade process.

It may happen that when you try to find the device again, the **Available devices** window will only show the IP address of the matrix but not the device type and serial number. The reason for that is the matrix may still be in bootload mode at that moment and the controllers cannot send any information about themselves. You can still double-click on the IP address and the Bootloader will establish the connection.

'No Controller Selected to Upgrade'

If you did not mark any checkboxes next to the controller types then the following message appears:

No controller selected to upgrade!

Click at least one of the checkboxes before pressing the **Upgrade Selected Firmwares** button.

'Invalid checksum'

The Bootloader checks if valid firmware files have been selected for the controllers. If an invalid file (not firmware file) has been selected, then the following message appears:

WARNING! Upgrade failed: Invalid checksum

Please select a valid firmware file.

'Invalid Controller Type'

If a firmware file has been selected for the wrong controller, the following message appears:

WARNING! Invalid controller type info for MX16x16DVI-Plus

Please select the appropriate firmware file for the controller.

'Invalid Checksum, Invalid Controller Type'

If the correct firmware file is selected for the controller but it somehow became corrupted (the checksum is incorrect), then the following message appears:

WARNING! Upgrade failed: Invalid checksum. Invalid controller type info for MX16x16DVI-Plus. Invalid hardware info for MX16x16DVI-Plus

Please contact support@lightware.com and get the correct firmware files.

9

Technologies

The following sections contain descriptions and useful technical information how the devices work in the background. The content is based on experiences and cases we met in the practice. These sections help to understand features and technical standards.

9.1. EDID Management

9.1.1. Understanding the EDID

The Extended Display Identification Data (EDID) is the passport of display devices (monitors, TV sets, projectors). It contains information about the capabilities of the display, such as supported resolutions, refresh rates (these are called Detailed Timings), the type and manufacturer of the display device, etc.

After connecting a source to a display (DVI, HDMI, DP), the source reads out the EDID to determine the resolution and refresh rate of the image to be transmitted.

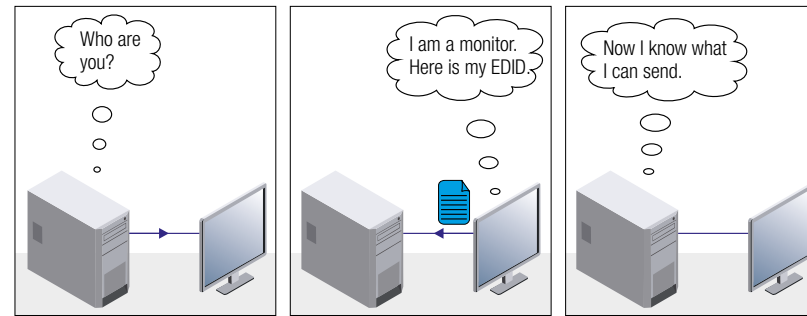

EDID Communication

Most DVI computer displays have 128-byte long EDID structure. However, Digital Televisions and HDMI capable displays may have another 128 bytes, which is called E-EDID and defined by CEA (Consumer Electronics Association). This extension contains information about additional Detailed Timings, audio capabilities, speaker allocation and HDMI capabilities. It is important to know that all HDMI capable devices must have CEA extension, but not all devices with CEA extension are HDMI capable.

Common Problems Related to EDID

Problem: “My system consists of the following: a computer, a Lightware device, a WUXGA (1920x1200) LCD monitor, and an SXGA (1280x1024) projector. I would like to see the same image on the monitor and the projector. What EDID should I choose on the Lightware device?”

Solution: If you want to see the image on both displays, you need to select the resolution of the smaller display (in this case SXGA), otherwise the smaller display may not show the higher resolution image.

Problem: “I have changed to a different EDID on an input port of the Lightware device to have a different resolution but nothing happens.”

Solution: Some graphics cards and video sources read out the EDID only after power-up and later they do not sense that EDID has been changed. You need to restart your source to make it read out the EDID again.

9.1.2. Advanced EDID Management

Each DVI sink (e.g. monitors, projectors, plasma displays, etc...) must support the EDID data structure. Source BIOS and operating systems are likely to query the sink using DDC2B protocol to determine what pixel formats and interface are supported. DVI standard uses EDID data structure to identify the monitor type and capabilities. Most DVI sources (VGA cards, set top boxes, etc.) will output DVI signal after accepting the connected sink's EDID information. In the case of EDID readout failure or missing EDID, the source will not output DVI video signal.

Lightware devices provide the Advanced EDID Management function that helps system integration. The built-in EDID Router can store and emulate factory pre-programmed- and User programmable EDIDs. The EDID of the attached monitors or projectors for each output are stored in a non-volatile memory. This way the EDID of a monitor is available when the monitor is unplugged or switched off.

Any EDID can be emulated on any input. An emulated EDID can be copied from the EDID router's memory (static EDID emulation), or from the last attached monitor's memory (dynamic EDID emulation). For example, the Lightware device can be set up to emulate a sink device, which is connected to one of the outputs. In this case, the EDID automatically changes, if the monitor is replaced with another display device (as long as it has a valid EDID).

EDID is independently programmable for all inputs without affecting each other. All inputs have their own EDID circuit.

INFO: The user is not required to disconnect the video cable to change an EDID as opposed to other manufacturer's products. EDID can be changed even if a source is connected to the input and powered ON.

INFO: When EDID has been changed, the router toggles the HOTPLUG signal for 2 seconds. Some sources do not sense this signal. In such cases, the source device must be restarted or powered OFF and ON again.

10

Appendix

- ▶ [EDID MANAGEMENT](#)
- ▶ [SPECIFICATIONS](#)
- ▶ [FACTORY EDID LIST](#)
- ▶ [VENTILATION](#)
- ▶ [MECHANICAL DRAWINGS](#)
- ▶ [FURTHER INFORMATION](#)

10.1. Specifications

General

Compliance	CE
EMC compliance (emission / immunity).....	EN 55032 / EN 55035
RoHS compliance	Yes
Warranty	3 years
Cooling.....	by cooling fans
Operating temperature	0 to +55°C (+32°F to +122°F)
Operating humidity	10% to 90% , noncondensing

Power

Power source	100-240V AC, 50-60Hz
Power consumption of MX9x9DVI-Plus (typ/max)	27W / 36 W
Power consumption of MX12x12DVI-Plus (typ/max)	31W / 44 W
Power consumption of MX16x16DVI-Plus (typ/max)	36W / 53 W
Power supply.....	internal

Enclosure

Material.....	1 mm steel
Dimensions in mm.....	482*/440W x 159.8D / 176.5H
Dimensions in inch	19*/17.3W x 6.3D x 7H
Rack mountable	yes
Net weight	5200 g
* with rack-mounting ears	

Video Signal

Standard	DVI 1.0, HDMI 1.3a
Input/output connectors	29-pole DVI-I digital only
Input cable equalization	yes, +12 dB fixed
Output pre-emphasis	yes, +6 dB fixed
+5V output current.....	500 mA continuous on each output
Data rate.....	all between 25 Mbps and 2.25 Gbps / TMDS channel
Resolutions.....	all between 640x480 and 1920x1200@60Hz or 2048x1080@60Hz

Color depth.....	maximum 36 bits, 12 bit/color
Color format	RGB, YCbCr 4:4:4
HDCP compliant.....	no
EDID emulation	yes, on each input port
EDID memory	50 factory preset, 50 user-programmable

RS-232 Control Port

Serial port connector	9-pole, D-SUB female RS-232
Baud rate	9600 Baud, 8 bit, 1 stop bit, no parity

10.2. Factory EDID List

Mem.	Resolution				Audio
F1	640 x	480	@ 60.0	Hz	-
F2	640 x	480	@ 75.0	Hz	-
F3	848 x	480	@ 60.0	Hz	-
F4	800 x	600	@ 50.0	Hz	-
F5	800 x	600	@ 60.30	Hz	-
F6	800 x	600	@ 74.99	Hz	-
F7	1024 x	768	@ 49.98	Hz	-
F8	1024 x	768	@ 60.0	Hz	-
F9	1024 x	768	@ 75.2	Hz	-
F10	1152 x	864	@ 75.0	Hz	-
F11	1280 x	768	@ 50.0	Hz	-
F12	1280 x	768	@ 59.92	Hz	-
F13	1280 x	768	@ 75.0	Hz	-
F14	1360 x	768	@ 60.1	Hz	-
F15	1364 x	768	@ 50.0	Hz	-
F16	1364 x	768	@ 59.93	Hz	-
F17	1364 x	768	@ 74.98	Hz	-
F18	1280 x	1024	@ 50.0	Hz	-
F19	1280 x	1024	@ 60.1	Hz	-
F20	1280 x	1024	@ 75.1	Hz	-
F21	1366 x	1024	@ 59.99	Hz	-
F22	1400 x	1050	@ 49.99	Hz	-
F23	1400 x	1050	@ 59.99	Hz	-
F24	1400 x	1050	@ 75.0	Hz	-
F25	1680 x	1050	@ 59.99	Hz	-
F26	1600 x	1200	@ 50.0	Hz	-
F27	1600 x	1200	@ 60.0	Hz	-
F28	1920 x	1200	@ 59.55	Hz	-
F29	1920 x	1200	@ 50.0	Hz	-
F30	1440 x	480i	@ 60.3	Hz	yes

Mem.	Resolution				Audio
F31	640 x	480	@ 59.94	Hz	yes
F32	720 x	480	@ 59.92	Hz	yes
F33	1440 x	576i	@ 50.6	Hz	yes
F34	720 x	576p	@ 50.0	Hz	yes
F35	1280 x	720p	@ 50.0	Hz	yes
F36	1280 x	720p	@ 60.0	Hz	yes
F37	1920 x	1080i	@ 50.3	Hz	yes
F38	1920 x	1080i	@ 50.0	Hz	yes
F39	1920 x	1080i	@ 60.5	Hz	yes
F40	1920 x	1080	@ 24.0	Hz	yes
F41	1920 x	1080	@ 24.99	Hz	yes
F42	1920 x	1080	@ 30.0	Hz	yes
F43	1920 x	1080	@ 50.0	Hz	yes
F44	1920 x	1080	@ 49.99	Hz	yes
F45	1920 x	1080	@ 60.0	Hz	yes
F46	2048 x	1080	@ 49.99	Hz	
F47	2048 x	1080	@ 50.0	Hz	
F48	2048 x	1080	@ 59.99	Hz	
F49	Universal EDID				yes
F50	2560 x	1600	@ 59.85	Hz	

Universal EDID

Most of the factory preset EDIDs include only one resolution to force the connected source give a signal at the desired resolution. Universal EDID allows multiple resolutions including all common VESA defined resolutions with audio support. The use of universal EDID is recommended for fast and easy system setup.

Please note that minor changes in the factory EDID list may be applied in farther firmware versions

10.3. Ventilation

WARNING! For the proper ventilation and to avoid overheating ensure enough free space around the appliance. Do not cover the appliance, let the ventilation holes free and never block or bypass the ventilators.

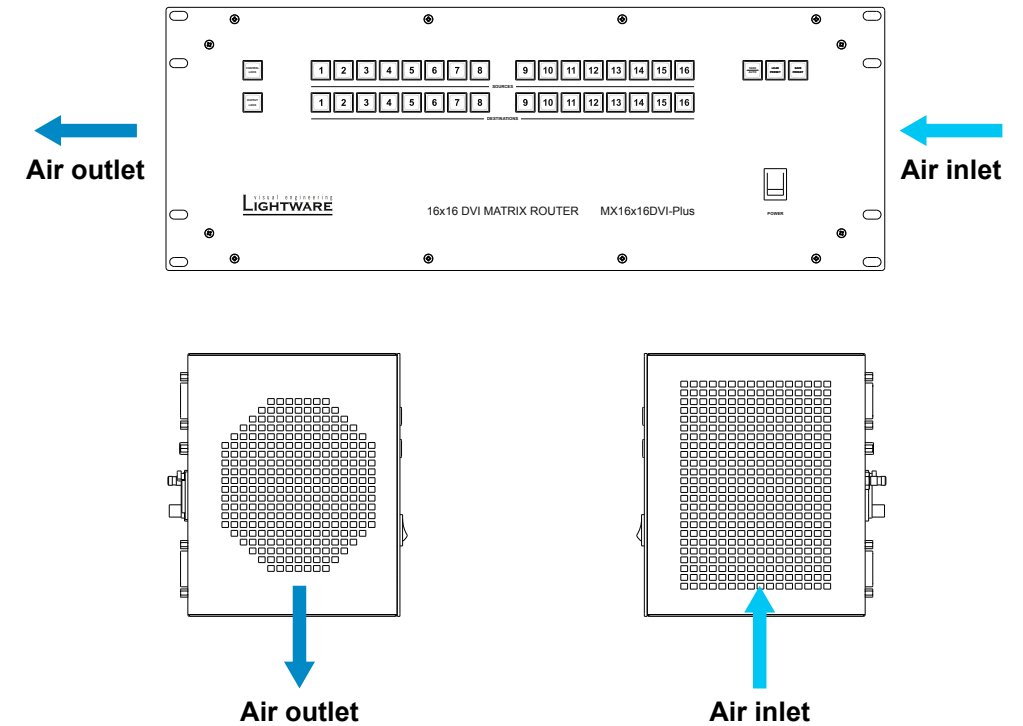

10.4. Mechanical Drawings

MX16x16DVI-Plus can be seen on the drawings but the dimensions are the same for all the three models. Dimensions are in mm.

Front View

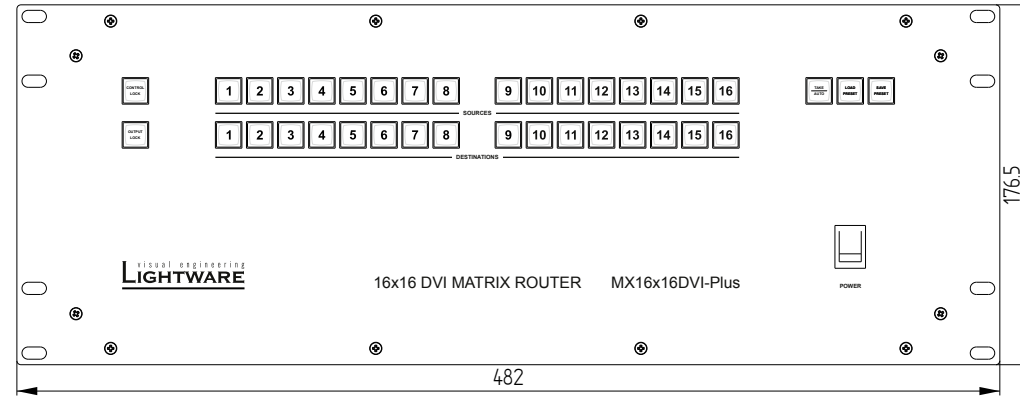

Rear View

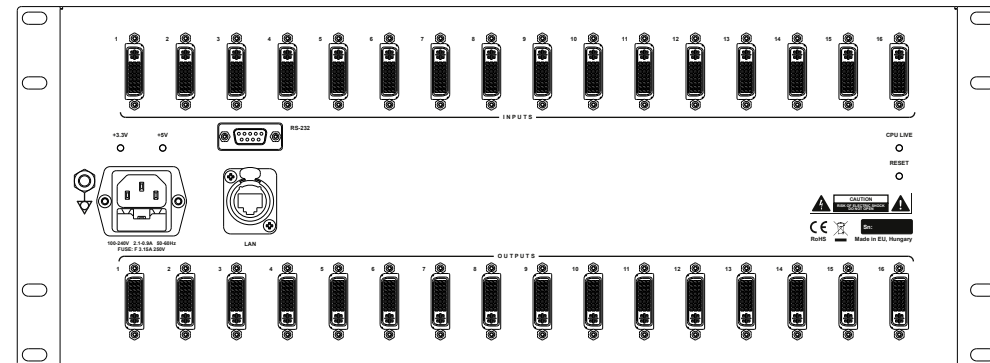

Side Views

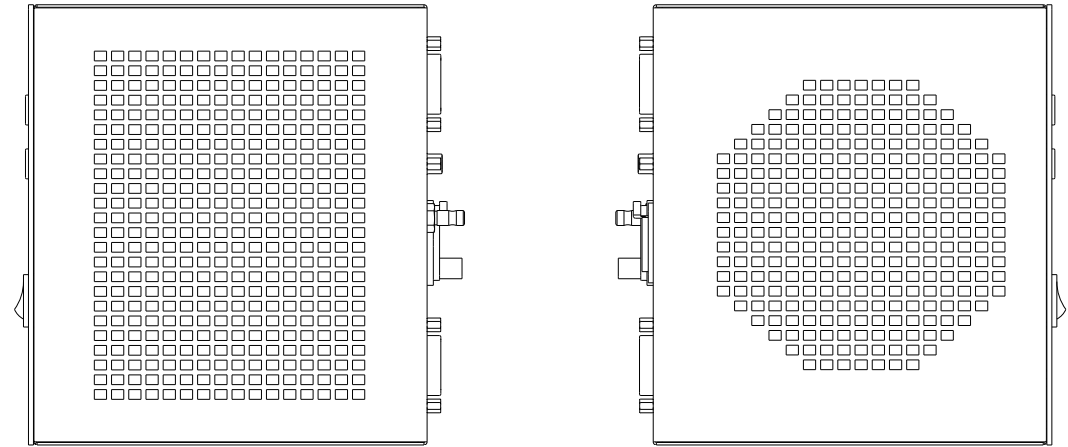

Top View

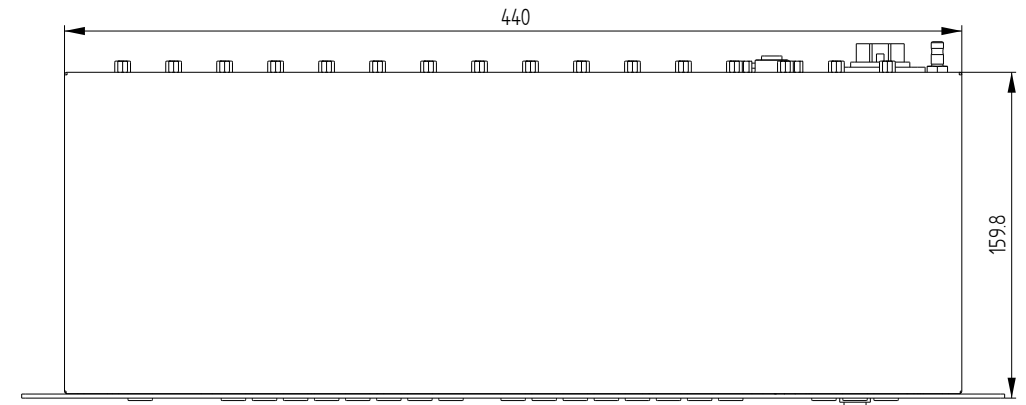

10.5. Further Information

Limited Warranty Statement

1. Lightware Visual Engineering LLC (Lightware) warrants to all trade and end user customers that any Lightware product purchased will be free from manufacturing defects in both material and workmanship for three (3) years from purchase unless stated otherwise below. The warranty period will begin on the latest possible date where proof of purchase/delivery can be provided by the customer. In the event that no proof can be provided (empty 'Date of purchase' field or a copy of invoice), the warranty period will begin from the point of delivery from Lightware.

1.1. 25G and MODEX product series will be subject to a seven (7) year warranty period under the same terms as outlined in this document.

1.2. If during the first three (3) months of purchase, the customer is unhappy with any aspect of a Lightware product, Lightware will accept a return for full credit.

1.3. Any product that fails in the first six (6) months of the warranty period will automatically be eligible for replacement and advanced replacement where available. Any replacements provided will be warranted for the remainder of the original unit's warranty period.

1.4. Product failures from six (6) months to the end of the warranty period will either be repaired or replaced at the discretion of Lightware. If Lightware chooses to replace the product then the replacement will be warranted for the remainder of the original unit's warranty period.

2. The above-stated warranty and procedures will not apply to any product that has been:

2.1. Modified, repaired or altered by anyone other than a certified Lightware engineer unless expressly agreed beforehand.

2.2. Used in any application other than that for which it was intended.

2.3. Subjected to any mechanical or electrical abuse or accidental damage.

2.4. Any costs incurred for repair/replacement of goods that fall into the above categories (2.1., 2.2., 2.3.) will be borne by the customer at a pre-agreed figure.

3. All products to be returned to Lightware require a return material authorization number (RMA) prior to shipment and this number must be clearly marked on the box. If an RMA number is not obtained or is not clearly marked on the box, Lightware will refuse the shipment.

3.1. The customer will be responsible for in-bound and Lightware will be responsible for out-bound shipping costs.

3.2. Newly repaired or replaced products will be warranted to the end of the originally purchased products warranty period.

Document Revision History

Rev.	Release date	Changes	Editor
Rev. 1.0	28-09-2012	Initial version	Zsolt Marko
Rev. 1.1	16-07-2015	Lightware Device Controller added, Bootloader upgraded, Typographical corrections and minor changes in the formatting.	Laszlo Zsedenyi
Rev. 1.2	15-12-2015	Safety instructions updated, CE page pulled out	Laszlo Zsedenyi
Rev. 2.0	05-05-2017	Connecting devices section added, Front panel operations upgraded, LDC chapter upgraded, Firmware upgrade section upgraded, Specifications upgraded, New document format applied.	Laszlo Zsedenyi
Rev. 2.1	03-07-2017	Safety-related section updated	Laszlo Zsedenyi
Rev. 3.0	02-03-2018	New document format introduced, graphical design changes.	Laszlo Zsedenyi

Contact Us

sales@lightware.com

+36 1 255 3800

support@lightware.com

+36 1 255 3810

Lightware Visual Engineering LLC.
Peterdy 15, Budapest H-1071, Hungary

www.lightware.com